

2023

GRATTONI



2023

GRATTONI

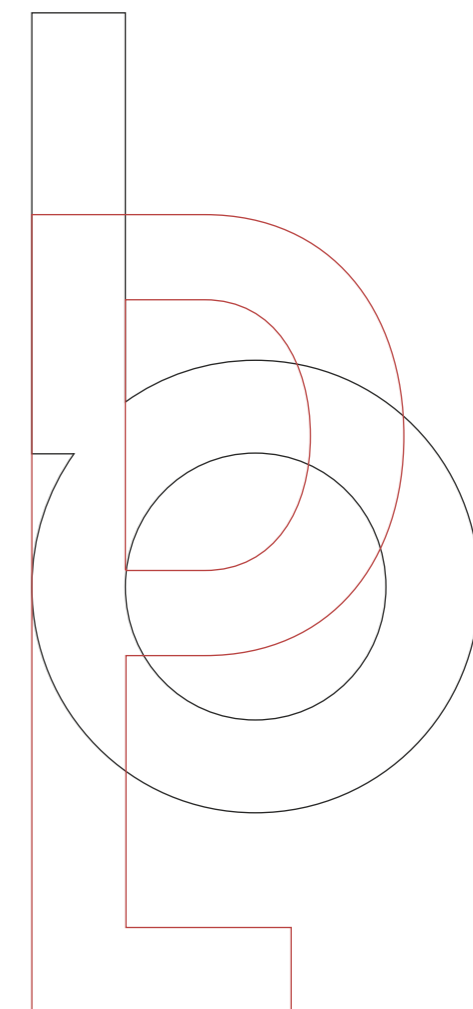

INDICE CONTENT



8

COMPOSIZIONI SETS

BARI	10
MUSES	16
PANAMA.....	20
NIZZA	26
MOJO	30
EASY.....	36
LEON.....	40
TAHITI.....	44
SOFT.....	50
COMO	56
CUBA.....	60
MINORCA.....	66
KOS	68
CRETA	72
FREEDOM	75
IVORY	80
ALVORY.....	84
MONACO.....	90



92

LETTINI SUNBEDS

MUSES	94
BARI	96
FLORES	82
PANAMA	102
EDEN.....	110
BITE.....	112
JOY	120
ANTIGUA	124
ANTIGUA LUX	126
GS 924 LUX	128
GS 927	132
GS 926	136
GS 928	138



142

SEDIE E SGABELLI CHAIRS AND STOOLS

BARI	144
MUSES	148
PANAMA	150
TAHITI	156
KOS	168
ATOL	170
CUBA	174
COMO	178
BAHZA	184
NANCY	186
MONACO.....	188
CANNES	190
GS 936	194
WINDI	200
CAPRI	204



208

TAVOLI TABLES

TOP	210
BARI	214
MILO	218
PANAREA	224
LIPARI.....	228
MIKONOS.....	232
ISLAND	234
JOLLY.....	238
GT 927	240
MALDIVES	242



244

LAMPADE LAMPS

STAR	245
LUX	246

GUIDATO DA UNA SPICCATO SENSIBILITÀ VERSO IL BELLO, IL TEAM GRATTONI RICERCA E SELEZIONA I MIGLIORI COMPLEMENTI D'ARREDO, PER UNA PERFETTA COMMISTIONE DI ESTETICA DELLE FORME E QUALITÀ DEI MATERIALI.

ESTETICA E QUALITÀ ISPIRANO LO STILE DI GRATTONI, CHE DA OLTRE TRENT'ANNI COLTIVA LA PROPRIA PASSIONE PER L'ARREDAMENTO ATTRAVERSO UN'INCESSANTE RICERCA DEL BELLO. IN UN PERFETTO EQUILIBRIO TRA TRADIZIONE E NUOVE TENDENZE, GRATTONI SELEZIONA E IMPORTA I MIGLIORI COMPLEMENTI D'ARREDO PER IL SETTORE RESIDENZIALE E CONTRACT, ATTINGENDO ALLA PROPRIA INESTIMABILE ESPERIENZA; UNA STORIA DI ARTIGIANATO CAPACE DI REINVENTARSI CON IL MUTARE DEI TEMPI E DELLE TENDENZE.

NATA NEL 1972 A SAN GIOVANNI AL NATISONE – CUORE DEL DISTRETTO ITALIANO DELLA SEDIA – COME PRODUTTRICE DI SEDUTE DAL DESIGN CLASSICO, L'AZIENDA SI SPECIALIZZA NEL 2010 NELL'ATTIVITÀ COMMERCIALE, IMPORTANDO COMPLEMENTI D'ARREDO DI QUALITÀ. TRA QUESTI SEDIE, DIVANETTI, POLTRONE, TAVOLI E BASI PER TAVOLI PER INTERNO ED ESTERNO, PENSATI PER IL MONDO RESIDENZIALE E CONTRACT.

ESPERTA SELEZIONATRICE DI PRODOTTI D'ARREDAMENTO, GRATTONI SI AFFIDA ALLA SPICCATO SENSIBILITÀ ESTETICA DEL SUO TEAM CHE PERMETTE DI INDIVIDUARE I COMPLEMENTI D'ARREDO PIÙ INTERESSANTI, IN UNA PERFETTA COMMISTIONE TRA DESIGN, FUNZIONALITÀ E QUALITÀ. LA RICERCA DEL BELLO È QUINDI UN'ATTIVITÀ COSTANTE CHE SI SVILUPPA ATTRAVERSO LE PIÙ IMPORTANTI FIERE DEL SETTORE E LE VISITE ALLE AZIENDE DI MAGGIORE INTERESSE.

L'ESTETICA SI LEGA INDISSOLUBILMENTE ALLA QUALITÀ. OGNI PRODOTTO SCELTO DEVE POTER GARANTIRE GLI STANDARD QUALITATIVI IMPOSTI DALL'AZIENDA, CHE RICHIEDE CONTROLLI METICOLOSI PRIMA DI OGNI SPEDIZIONE VERSO LA SUA SEDE. I CONTROLLI VENGONO POI REPLICATI ALL'INTERNO DEI CINQUEMILA METRI QUADRI DI AREA GIACENZE, SITUATA IN PROSSIMITÀ DEGLI UFFICI DELL'AZIENDA; UNO SPAZIO SEMPRE RIFORNITO CHE PERMETTE A GRATTONI DI SPEDIRE OGNI ORDINE IN GIORNATA. IL SERVIZIO, CELERE E ORGANIZZATO, RIFLETTE INFATTI LA PRECISIONE DELLA FAMIGLIA GRATTONI, SEMPRE DISPONIBILE PER CONSIGLIARE E ASSISTERE IL CLIENTE.

IDOL, CON LA SUA PERSONALITÀ RAFFINATA E DECISA, È LA LINEA DI PRODOTTI DEDICATA ALL'ARREDAMENTO OUTDOOR CHE PORTA L'ATTIVITÀ DI SELEZIONE DI GRATTONI AD UN NUOVO LIVELLO. UN'ISPIRAZIONE PER MODERNE LOUNGE ALL'ARIA APERTA, CHE ANTICIPA E CREA NUOVI TREND.



A CONTRIBUIRE IN MODO DETERMINANTE ALLA CRESCITA CONTINUA DELL'ATTIVITÀ È PERÒ SOPRATTUTTO LA PASSIONE, CHE ALIMENTA L'INTERESSE E IL COINVOLGIMENTO DI OGNI MEMBRO DELL'AZIENDA PER IL PROPRIO LAVORO E PER IL SETTORE DELL'ARREDAMENTO.

È PROPRIO QUESTA GRANDE PASSIONE AD AVER ISPIRATO IDOL: LA LINEA DI PRODOTTI, INTERAMENTE DEDICATA AL MONDO DELL'OUTDOOR, CHE RACCOGLIE GLI ELEMENTI DI DESIGN PIÙ INTERESSANTI E ORIGINALI SECONDO GRATTONI. UNA RISTRETTA SELEZIONE DI DIVANI, SALOTTI, POLTRONCINE E LETTINI DALLO STILE ELEGANTE E RICERCATO, REALIZZATI CON GRANDE CURA PER OGNI DETTAGLIO E CON MATERIALI DI OTTIMA QUALITÀ, PENSATI PER DURARE A LUNGO E RESISTERE A QUALSIASI CONDIZIONE ATMOSFERICA.

CON IDOL, GRATTONI PORTA LA PROPRIA ATTIVITÀ DI SELEZIONE AD UN LIVELLO PIÙ ALTO. ASSECONDARE LE TENDENZE NON BASTA: ATTRAVERSO UN PROFONDO STUDIO DEL MERCATO E DELLA SOCIETÀ, GRATTONI SI PONE L'OBIETTIVO DI ANTICIPARE E CREARE NUOVI TREND, PROPONENDO UNA LINEA DI PRODOTTI DALLA PERSONALITÀ RAFFINATA MA DECISA. OGNI ELEMENTO DI IDOL RIFLETTE INFATTI LA VOLONTÀ DELL'AZIENDA DI ISPIRARE LA CREAZIONE DI RILASSANTI E MODERNE LOUNGE ALL'ARIA APERTA, CONVERSANDO CON ARCHITETTI E PROGETTISTI NELL'UNIVERSALE LINGUAGGIO DELLA BELLEZZA.

**ESPERTI
SELEZIONATORI
DEL DESIGN**

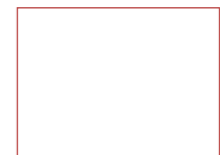

GUIDED BY THEIR EXCEPTIONAL AESTHETIC SENSIBILITY, THE GRATTONI TEAM SOURCE AND SELECT THE FINEST FURNISHINGS AROUND, FLAWLESSLY FUSING VISUALLY APPEALING FORMS AND SUPERIOR MATERIALS.

GRATTONI HAS BEEN NURTURING A PASSION FOR FURNITURE FOR OVER 30 YEARS. IN ITS TIRELESS PURSUIT OF BEAUTY, IT HAS MADE QUALITY AND AESTHETIC APPEAL THE CORNERSTONES OF ITS STYLE. GRATTONI HAS PROVED CAPABLE OF REINVENTING ITSELF TO ADAPT TO CHANGING TIMES AND FASHIONS. DRAWING ON ITS INVALUABLE EXPERIENCE IN CRAFT PRODUCTION, IT ESTABLISHES A PERFECTLY POISED BLEND OF TRADITIONS AND THE LATEST TRENDS BY SELECTING AND IMPORTING THE FINEST FURNISHINGS FOR THE HOME AND CONTRACT MARKETS.

THE COMPANY WAS FOUNDED IN 1972 IN SAN GIOVANNI AL NATISONE, IN THE HEART OF THE ITALIAN CHAIR MANUFACTURING DISTRICT. HAVING STARTED OUT AS A PRODUCER OF CHAIRS WITH CLASSIC DESIGNS, SINCE 2010 IT HAS BEEN A SPECIALIST IMPORTER AND TRADER OF SUPERIOR FURNISHINGS. ITS SELECTION CATERS TO BOTH THE HOME AND CONTRACT MARKETS AND INCLUDES CHAIRS, SOFAS, ARMCHAIRS, TABLES AND TABLE BASES FOR INDOOR AND OUTDOOR USE.

THANKS TO THE EXCEPTIONAL AESTHETIC SENSIBILITY OF ITS TEAM, GRATTONI PROFICIENTLY SELECTS FIRST-RATE FURNISHING PRODUCTS. IT PICKS OUT THE MOST INTERESTING FURNISHINGS AROUND, FLAWLESSLY FUSING SUPERB DESIGNS, PRACTICALITY AND QUALITY. ON THEIR CEASELESS SEARCH FOR THE MOST ATTRACTIVE CREATIONS, THE TEAM GO TO THE TOP TRADE FAIRS IN THE FIELD AND VISIT ALL OF THE MOST INTERESTING COMPANIES.

IN ALL OF THE PRODUCTS, VISUAL APPEAL MUST GO HAND IN HAND WITH QUALITY. EVERY ITEM SELECTED HAS TO MEET THE QUALITY STANDARDS SET BY THE COMPANY, WHICH DEMANDS METICULOUS CHECKS BEFORE EVERY SHIPMENT TO ITS PREMISES. THE CHECKS ARE THEN REPEATED

IN THE 5,000 M² WAREHOUSE NEAR THE COMPANY'S OFFICES. IT IS ALWAYS WELL STOCKED, WHICH MEANS THAT GRATTONI IS ABLE TO SHIP ALL OF ITS ORDERS ON THE DAY THEY ARRIVE. THE PROMPT, EFFICIENT SERVICE REFLECTS THE SCRUPULOUS NATURE OF THE GRATTONI FAMILY, WHO ARE ALWAYS HAPPY TO ADVISE AND HELP CUSTOMER



THE KEY FACTOR BEHIND THE CONSTANT GROWTH OF THE BUSINESS IS THE PASSION THAT DRIVES THE INVESTMENT AND ENGAGEMENT OF ALL OF THE MEMBERS OF THE TEAM IN BOTH THEIR WORK AND THE FURNITURE INDUSTRY AS A WHOLE.

IT WAS THIS SENSE OF DEVOTION THAT INSPIRED IDOL: A LINE OF OUTDOOR PRODUCTS FEATURING WHAT GRATTONI CONSIDERS TO BE THE MOST INTERESTING AND ORIGINAL DESIGNS AROUND. THE SELECT RANGE OF SOFAS, LOUNGE SETS, ARMCHAIRS AND SUN LOUNGERS IS STYLISH AND SOPHISTICATED. GREAT ATTENTION TO DETAIL AND HIGH-QUALITY MATERIALS ENSURE THAT THEY ARE LONG LASTING AND ABLE TO WITHSTAND ALL WEATHER CONDITIONS.

WITH IDOL, GRATTONI IS TAKING ITS SELECTION PROCESS TO ANOTHER LEVEL. IT IS NOT CONTENT TO KEEP UP WITH THE LATEST TRENDS: THROUGH IN-DEPTH RESEARCH INTO SOCIETY AND THE MARKET, GRATTONI AIMS TO BE ONE STEP AHEAD AND SET NEW TRENDS BY PRESENTING A LINE OF PRODUCTS WITH REFINED BUT BOLD CHARACTERS. EVERY FACET OF IDOL EMBODIES THE COMPANY'S DESIRE TO INSPIRE RELAXING, MODERN OUTDOOR LOUNGES, AS IT CONVERSES WITH ARCHITECTS AND DESIGNERS IN THE UNIVERSAL LANGUAGE OF BEAUTY.

**EXPERTLY
SELECTING
EXCEPTIONAL
DESIGN**

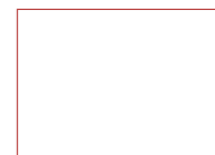

8

SET COMPOSIZIONI

LE COMPOSIZIONI SONO
ARCIPELAGHI: PEZZI UNICI DI
UN INSIEME TENUTO LEGATO
DALLE FORME E DALLA BELLEZZA.
ACCOGLIENTI COME UNA
COLLEZIONE DI ISOLE NEL MARE,
PERFETTI NELLA LORO NATURALE
DISPOSIZIONE.

THE SETS ARE ARCHIPELAGOS:
UNIQUE PARTS OF A WHOLE
HELD TOGETHER BY FORMS
AND BEAUTY. AS WELCOMING
AS A GROUP OF ISLANDS IN THE
SEA, PERFECT IN THEIR NATURAL
ARRANGEMENT.



BARI SET

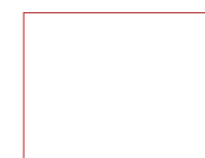

COORDINATO COMPOSTO DA UN DIVANO 2 POSTI, DUE POLTRONE E 1 TAVOLINO CON PIANO IN LAMIERA DI ALLUMINIO.

STRUTTURA IN ALLUMINIO E RIVESTIMENTO CON CORDA SINTETICA WINTech.

CUSCINERIA SFODERABILE IN TESSUTO OLEFIN.

LIVING SET WITH ONE SOFA 2 SEATERS, TWO ARMCHAIRS AND A ALUMINIUM TOP COFFEE TABLE.

ALUMINIUM FRAME WEAIVED WITH WINTech SYNTHETIC ROPE.

UPHOLSTERED CUSHIONS WITH OLEFIN FABRIC.



BARI SET

IL SET BARI È IL RISULTATO DELL'INCONTRO FRA ELEGANZA E SEMPLICITÀ, IN CUI IL RIVESTIMENTO IN CORDA SINTETICA WINTECH, CHE RIPORTA ALL'ATMOSFERA VIBRANTE DELLA CITTÀ, SI CONIUGA CON IL COMFORT DELLA CUSCINERIA SFODERABILE.

THE BAR SET I IS THE RESULT OF THE COMBINATION BETWEEN ELEGANCE AND SIMPLICITY, IN WHICH THE COATING IN WINTECH SYNTHETIC ROPE, WHICH BRINGS BACK THE VIBRANT ATMOSPHERE OF THE CITY, COMBINES WITH THE COMFORT OF THE REMOVABLE CUSHIONS.

POLTRONCINA CON STRUTTURA IN ALLUMINIO E RIVESTIMENTO IN CORDA SINTETICA WINTECH. CUSCINERIA SFODERABILE CON TESSUTO OLEFIN.

ALUMINIUM ARMCHAIR COVERED WITH WINTECH SYNTHETIC ROPE. REMOVABLE CUSHIONS WITH OLEFIN FABRIC.



BARI SET

CIRCONDARSI DI BELLEZZA PERMETTE DI VIVERE DI BELLEZZA. QUESTO TRASPARE DAL SET BARI, METAFORA DI UNO STILE UNICO, CHE RIPORTA ALLE SERATE TRASCORSE IN UN CONNUBIO DI RELAX E CONVIVIO.

SURROUNDING YOURSELF WITH BEAUTY, ALLOWS YOU TO LIVE OF BEAUTY. THIS SHINES THROUGH THE BARI SET, A METAPHOR OF A UNIQUE STYLE, WHICH BRINGS BACK TO THE EVENINGS SPENT IN A COMBINATION OF RELAX AND CONVIVIALITY.

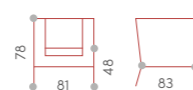

POLTRONA
1 SEATER



TAVOLINO
SMALL TABLE



DIVANO 2 POSTI
SOFA 2 SEATERS

MUSES SET

COORDINATO COMPOSTO DA UN DIVANO 2 POSTI, DUE POLTRONE E 1 TAVOLINO CON PIANO IN LAMIERA DI ALLUMINIO. STRUTTURA IN ALLUMINIO E RIVESTIMENTO CON CORDA SINTETICA WINTECH. CUSCINERIA SFODERABILE IN TESSUTO OLEFIN.

LIVING SET WITH ONE SOFA 2 SEATERS, TWO ARMCHAIRS AND A ALUMINIUM TOP COFFEE TABLE. ALUMINIUM FRAME WEAVED WITH WINTECH SYNTHETIC ROPE. UPHOLSTERED CUSHIONS WITH OLEFIN FABRIC.

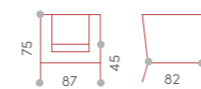

POLTRONA
1 SEATER



TAVOLINO
SMALL TABLE

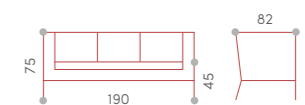

DIVANO 2 POSTI
SOFA 2 SEATERS

MUSES SET

TRAMITE IL SET MUSES SI MANIFESTA UN CARATTERE DECISO, UNA FORZA STRUTTURALE ED ESTETICA PRONTA AD ADORNARE IL PATIO CON ELEGANZA E SICUREZZA.

THROUGH THE MUSES SET, A STRONG CHARACTER IS MANIFESTED, A STRUCTURAL AND AESTHETIC STRENGTH READY TO ADORN THE PATIO WITH ELEGANCE AND SAFETY.

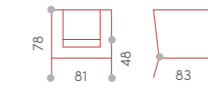

POLTRONA
1 SEATER

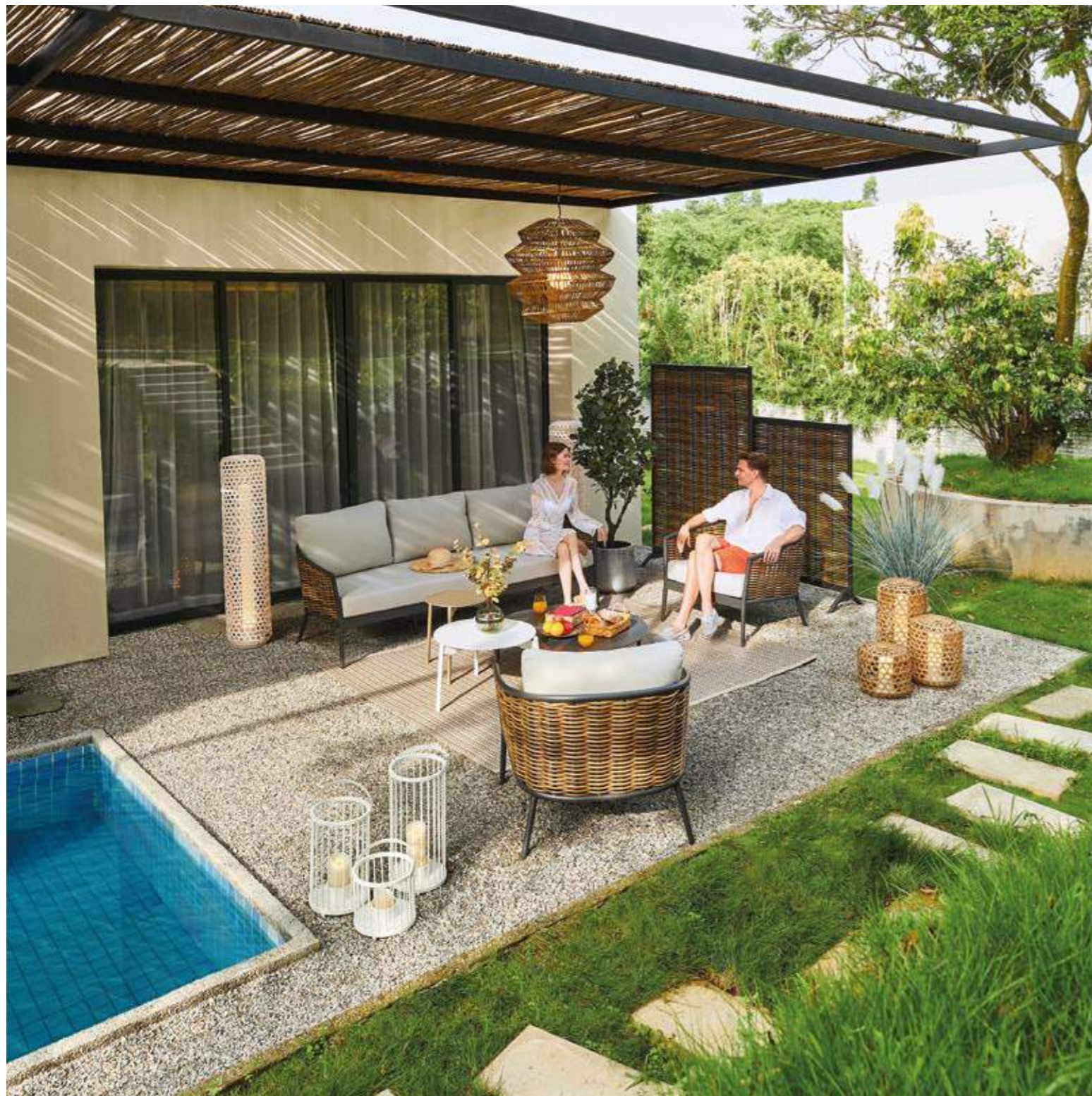

PANAMA SET



PANAMA SET

UN RICHIAMO IMMEDIATO ALLE RILASSANTI ATMOSFERE CARAIBICHE DA UNA PARTE E ALLE INCREDIBILI ONDE DEL MARE DALL'ALTRA. PANAMA COLLEGA DUE MONDI, QUELLO DEL RIPOSO E DEL RELAX CON QUELLO DELLA VEGLIA E DELLA CONVIVIALITÀ.

AN IMMEDIATE REMINDER OF A RELAXING CARIBBEAN ATMOSPHERE ON ONE SIDE, AND THE INCREDIBLE WAVES OF THE SEA ON THE OTHER. PANAMA CONNECTS TWO WORLDS, THAT OF REST AND RELAXATION WITH THAT OF WAKEFULNESS AND CONVIVIALITY.

COORDINATO IMPILABILE CON STRUTTURA IN ALLUMINIO E RIVESTIMENTO IN TEXTILENE E GOMMA, COMPOSTO DA UN DIVANO, DUE POLTRONE E UN TAVOLINO CON PIANO IN ALLUMINIO. CUSCINERIA SFODERABILE IN TESSUTO TEXTILENE.

STACKABLE ALUMINIUM SET COVERED WITH TEXTYLENE AND RUBBER ROPE WITH ONE SOFA, TWO ARMCHARIS AND A TABLE WITH ALUMINIUM TOP. TEXTYLENE CUSHIONS.



PANAMA SET

UN INCONTRO DI FORME DOVE LE LINEE ESSENZIALI RISALTANO IMMEDIATAMENTE AGLI OCCHI E AL TATTO. SEGUENDO I TRATTI CURVI DEI SINGOLI ELEMENTI SI RICONOSCE IMMEDIATAMENTE GLI ASPETTI ESSENZIALMENTE ERGONOMICI DEL SET PANAMA.

A MEETING OF SHAPES, WHERE THE ESSENTIAL LINES ARE IMMEDIATELY STRIKING AND WONDERFUL TO THE TOUCH. FOLLOWING THE CURVED LINES OF THE INDIVIDUAL ELEMENTS, ONE CAN IMMEDIATELY RECOGNISE THE ESSENTIALLY ERGONOMIC ASPECTS OF THE PANAMA SET.

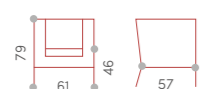

POLTRONA
1 SEATER

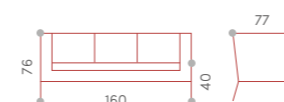

DIVANO 2 POSTI
SOFA 2 SEATERS



TAVOLINO
SMALL TABLE



NIZZA SET

COORDINATO CON STRUTTURA IN ALLUMINIO E RIVESTIMENTO IN CORDA TEXTILENE E GOMMA, COMPOSTO DA DUE POLTRONE, UN DIVANO E UN TAVOLO CON PIANO IN ALLUMINIO. CUSCINERIA SFODERABILE.

ALUMINIUM SET WITH TWO ARMCHAIRS, ONE SOFA COVERED WITH TEXTYLENE AND RUBBER ROPE, AND A TABLE WITH ALUMINIUM TOP. OLEFIN FABRIC CUSHIONS.



NIZZA SET

CARATTERE DECISO CHE SI ESPRIME IN LINEE SOTTILI E FORME GEOMETRICHE. NIZZA SFOGGIA IL PROPRIO BON-TON ATTRAVERSO UNA COMPOSIZIONE DI IMBOTTITI DALL'ELEGANZA TOTAL BLACK, RESA GENTILE DALLE TINTE CALDE DELLA STRUTTURA.

SLENDER LINES AND GEOMETRIC SHAPES GIVE CONCRETE FORM TO THIS PRODUCT'S BOLD CHARACTER. NIZZA'S REFINED QUALITIES ARE ENCAPSULATED BY THE ALL-BLACK ELEGANCE OF THE PADDING ARRANGEMENTS, WHICH ARE GIVEN A DELICATE TWIST BY THE WARM HUES OF THE FRAME.



TELAIO IN ALLUMINIO VERNICIATO A POLVERI; INTRECCIO IN CORDA TEXTILENE, CUSCINO IN GOMMA E TESSUTO OLEFIN.

POWDER-COATED ALUMINIUM FRAME; TEXTILENE ROPE WEAVE, RUBBER CUSHION WITH OLEFIN FABRIC COVER.

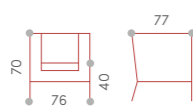

POLTRONA
1 SEATER



TAVOLINO
SMALL TABLE

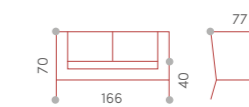

DIVANO 2 POSTI
SOFA 2 SEATERS

MOJO SET

COORDINATO CON STRUTTURA IN ALLUMINIO E RIVESTIMENTO IN CORDA TEXTILENE E GOMMA, COMPOSTO DA DUE POLTRONE, UN DIVANO E UN TAVOLINO CON PIANO IN ALLUMINIO.

CUSCINERIA SFODERABILE IN TESSUTO ACRILICO.

ALUMINIUM SET WITH TWO ARMCHAIRS, ONE SOFA COVERED WITH TEXTYLENE AND RUBBER ROPE, AND A TABLE WITH ALUMINIUM TOP.

ACRYLIC FABRIC CUSHIONS.



MOJO SET

IL MOJO ERA UN PICCOLO SACCHETTO CHE NELLA TRADIZIONE POPOLARE AVEVA DIVERSI USI. OGGI, CON UNA ELEGANTE REINTERPRETAZIONE IN CHIAVE MODERNA, GLI È STATO DONATO UNA NUOVA DESTINAZIONE. COME UN GENTILE BENVENUTO ECCO MOJO: ACCOGLIENTE E AVVOLGENTE.

THE MOJO WAS A SMALL BAG THAT HAD SEVERAL USES IN POPULAR TRADITION. TODAY, AN ELEGANT AND MODERN REINTERPRETATION HAS GIVEN IT A NEW USE. AS A WARM WELCOME, HERE IS MOJO: ACCOMMODATING AND ALL EMBRACING.

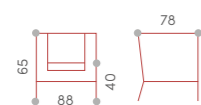

POLTRONA
1 SEATER



TAVOLO
TABLE

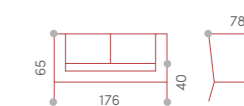

DIVANO 2 POSTI
SOFA 2 SEATERS

MOJO SET



EASY SET

COORDINATO CON STRUTTURA IN ALLUMINIO E RIVESTIMENTO IN CORDA POLIESTERE Ø 6 MM, COMPOSTO DA UN DIVANO 2 POSTI, DUE POLTRONE E UN TAVOLINO CON PIANO IN ALLUMINIO. CUSCINERIA SFODERABILE IN TESSUTO ACRILICO.

ALUMINIUM SET COVERED WITH Ø 6 MM POLYESTER ROPE WITH ONE SOFA 2 SEATERS, TWO ARMCHAIRS AND A TABLE WITH ALUMINIUM TOP. ACRYLIC FABRIC CUSHIONS.



EASY SET

UNA RIVISITAZIONE IN CHIAVE PIÙ MORBIDA ED AVVOLGENTE DELLO STILE INDUSTRIALE PER OFFRIRE UN DESIGN E UN COMFORT DAVVERO UNICI. EASY È LA SOLUZIONE PRATICA E INTELLIGENTE CHE SI LASCIA CONTAMINARE DAGLI ELEMENTI CREANDO UNA PERFETTA ARMONIA IN OGNI CONTESTO.

A SOFTER AND MORE EMBRACING REVISITATION OF THE INDUSTRIAL STYLE TO PROVIDE A TRULY UNIQUE DESIGN AND SENSE OF COMFORT. EASY IS THE PRACTICAL AND INTELLIGENT SOLUTION THAT ALLOWS ITSELF TO BE "CONTAMINATED" BY THE ELEMENTS, CREATING PERFECT HARMONY IN EVERY SETTING.

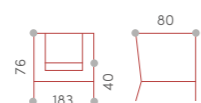

POLTRONA
1 SEATER

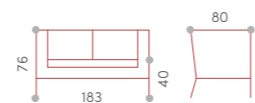

DIVANO 2 POSTI
SOFA 2 SEATERS



TAVOLINO
SMALL TABLE



LEON SET

COORDINATO CON STRUTTURA IN ALLUMINIO E RIVESTIMENTO IN CORDA ACRILICA E GOMMA, CON TRATTAMENTO TEFLON, COMPOSTO DA 2 DIVANI, UN ANGOLO ED UN TAVOLINO CON PIANO IN VETRO.

ALUMINIUM SET WITH 2 SOFAS, ONE CORNER COVERED WITH ACRYLIC ROPE TEFLON TREATED, AND A TABLE WITH A GLASS TOP. ACRYLIC FABRIC CUSHIONS.



LEON SET

L'IDEALE DI RELAX, FA VIAGGIARE LA MENTE VERSO SPIAGGE SOLEGGIATE E PARADISI NATURALI. LEON RIPRENDE LE TINTE DORATE DELLA SABBIA IN UNA COLLEZIONE DI CONFORTEVOLI SEDUTE DALL'INTRECCIO MORBIDO E DAL DESIGN INNOVATIVO. UNA SUBLIMAZIONE DI COMODITÀ ED ESTETICA.

IDEALLY, WHEN YOU ARE RELAXING YOUR MIND SHOULD CARRY YOU AWAY TO SUNNY BEACHES AND NATURAL PARADISES. LEON BRINGS THE GOLDEN HUES OF SAND TO LIFE IN A COLLECTION OF COMFORTABLE SEATS WITH SOFT WEAVES AND INNOVATIVE DESIGNS. IT TAKES COMFORT AND AESTHETIC APPEAL TO BREATHTAKING HEIGHTS.



INTRECCIO IN GOMMA E CORDA ACRILICA IDROREPELENTE. CUSCINO IN GOMMAE TESSUTO ACRILICO. SFODERABILE, RESISTENTE A MACCHIE E RAGGI UV

RUBBER AND ACRYLIC ROPE WEAVE, WITH TEFLON WATERPROOFING ON THE FABRIC RUBBER CUSHION WITH A STAIN-RESISTANT, UV-RESISTANT REMOVABLE ACRYLIC FABRIC COVER



TAVOLINO /
COFFEE TABLE

TAVOLO CON PIANO IN VETRO
EFFETTO PIETRA

TABLE WITH STONE-EFFECT
GLASS TOP

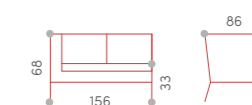

DIVANO 2 POSTI
SOFA 2 SEATERS

TAHITI SET

COORDINATO IMPILABILE CON STRUTTURA IN ALLUMINIO E RIVESTIMENTO IN CORDA ACRILICA. COMPOSTO DA UN DIVANO, DUE POLTRONE E UN TAVOLINO CON PIANO IN ALLUMINIO. CUSCINERIA SFODERABILE IN TESSUTO TEXTILENE.

STACKABLE ALUMINIUM SET COVERED WITH POLYOLEFIN ROPE WITH ONE SOFA, TWO ARMCHAIRS AND A TABLE WITH ALUMINIUM TOP. TEXTYLENE CUSHIONS.



TAHITI SET

COSÌ INTENSAMENTE ELEGANTE, TAHITI È UNA COMPOSIZIONE CHE RIMANE SCOLPITA NELLA MEMORIA GRAZIE AD UN BILANCIAMENTO EQUILIBRATO TRA LA VOGLIA DI SOLIDITÀ DELLE STRUTTURE E IL DESIDERIO DI COMFORT E STILE DEGLI IMBOTTITI.

SO INTENSELY ELEGANT, TAHITI IS A COMPOSITION THAT REMAINS ENGRAVED IN THE MEMORY THANKS TO A HARMONIOUS BALANCE BETWEEN THE DESIRE FOR SOLID STRUCTURES AND THE DESIRE FOR COMFORTABLE AND STYLISH UPHOLSTERY.

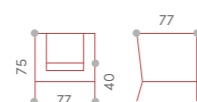

POLTRONA
1 SEATER

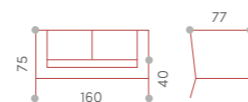

DIVANO 2 POSTI
SOFA 2 SEATERS



ISLAND BIG

TAHITI SET

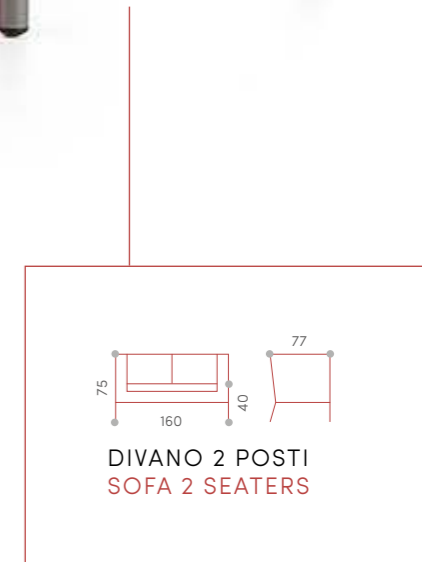
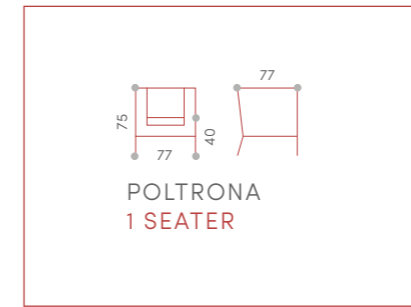

SOFT SET

COORDINATO CON STRUTTURA IN ALLUMINIO E RIVESTIMENTO IN CORDA POLYOLEFIN, COMPOSTO DA UN DIVANO 2 POSTI, DUE POLTRONE E IN TAVOLINO CON PIANO IN ALLUMINIO - OPPURE COMPOSTO DA DUE DIVANI CON BRACCIOLO, UN ANGOLO E TAVOLINO CON PIANO IN ALLUMINIO.

RIVESTIMENTO CON TESSUTO AXROMA E GOMMA CON RIVESTIMENTO IDROREPELENTE.

ALUMINIUM SET COVERED WITH POLYOLEFIN ROPE WITH ONE SOFA 2 SEATERS, TWO ARMCHAIRS AND AN ALUMINIUM TOP COFFEE TABLE - OR WITH TWO SOFAS 2 SEATERS WITH ONE ARM, ONE CORNER SOFA AND AN ALUMINIUM TOP COFFEE TABLE.

UPHOLSTERED WITH AXROMA FABRIC AND FOAM COVERED WITH A WATER-REPELLENT BAG.



SOFT SET

ATTRAVERSO LE LINEE MORBIDE DELLE STRUTTURE E DEI CUSCINI, VENIAMO IMMEDIATAMENTE TRAVOLTI DA UN'ATMOSFERA DI RELAX: IL SET SOFT EVOCA UNA SENSAZIONE DI COMFORT, DEL CALORE DI UN ABBRACCIO.

THROUGH THE SOFT LINES OF THE STRUCTURES AND CUSHIONS, WE ARE IMMEDIATELY OVERWHELMED BY AN ATMOSPHERE OF RELAX: THE SOFT SET EVOKES A FEELING OF COMFORT, THE WARMTH OF A HUG.

COORDINATO CON STRUTTURA IN ALLUMINIO E RIVESTIMENTO IN CORDA POLYOLEFIN, COMPOSTO DA UN DIVANO DUE POSTI, DUE POLTRONE ED UN TAVOLINO CON PIANO IN ALLUMINIO. CUSCINERIA IN TESSUTO ACRILICO E GOMMA RESISTENTE ALL'ACQUA.

ALUMINIUM SET COVERED WITH POLYOLEFIN ROPE, COMPOSED BY ONE SOFA 2 SEATERS, TWO ARMCHAIRS AND AN ALUMINIUM TOP COFFEE TABLES. ACRYLIC FABRIC AND WATER RESISTANT FOAM.

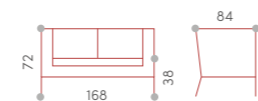

DIVANO 2 POSTI
SOFA 2 SEATERS



TAVOLINO
FOOTREST

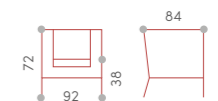

POLTRONA
1 SEATER

SOFT SET



COORDINATO CON STRUTTURA IN ALLUMINIO E RIVESTIMENTO IN CORDA POLYOLEFIN, COMPOSTO DA DUE DIVANI DUE POSTI, UN ELEMENTO ANGOLARE ED UN TAVOLINO CON PIANO IN ALLUMINIO. CUSCINERIA IN TESSUTO ACRILICO E GOMMA RESISTENTE ALL'ACQUA.

ALUMINIUM SET COVERED WITH POLYOLEFIN ROPE, COMPOSED BY TWO SOFA 2 SEATERS, ONE CORNER AND AN ALUMINIUM TOP COFFEE TABLES. ACRYLIC FABRIC AND WATER RESISTANT FOAM.

COMO SET

COORDINATO CON STRUTTURA IN ALLUMINIO E RIVESTIMENTO IN CORDA POLIESTERE Ø 9 MM, COMPOSTO DA UN DIVANO 2 POSTI, DUE POLTRONE E UN TAVOLINO CON PIANO IN ALLUMINIO. CUSCINERIA SFODERABILE IN TESSUTO OLEFIN.

ALUMINIUM SET COVERED WITH Ø 9 MM POLYESTER ROPE WITH ONE SOFA 2 SEATERS, TWO ARMCHAIRS AND A TABLE WITH ALUMINIUM TOP. OLEFIN FABRIC CUSHIONS.

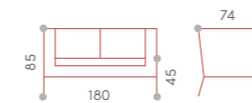

DIVANO 2 POSTI
SOFA 2 SEATERS

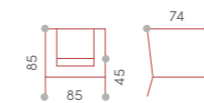

POLTRONA
1 SEATER



COMO SET

LA STRUTTURA IN ALLUMINIO, RIVESTITA IN CORDA, DEL SET COMO, DONA UN EFFETTO DECISO ALL'AMBIENTE: TRAMITE QUESTO MINIMALISMO ESTETICO, VIENE RICHIAMATA UN'ATMOSFERA DI CLASSE E RICERCATEZZA.

THE ALUMINIUM STRUCTURE, COVERED IN ROPE, OF THE COMO SET, GIVES A DECISIVE EFFECT TO THE ENVIRONMENT: THROUGH THIS MINIMALISTIC AESTHETIC AN ATMOSPHERE OF CLASS AND REFINEMENT IS RECALLED.



CUBA SET

COORDINATO CON STRUTTURA IN ALLUMINIO E RIVESTIMENTO IN CORDA POLIESTERE Ø 6 MM, COMPOSTO DA UN DIVANO 2 POSTI, DUE POLTRONE E UN TAVOLINO CON PIANO IN ALLUMINIO. CUSCINERIA SFODERABILE IN TESSUTO OLEFIN.

ALUMINIUM SET COVERED WITH Ø 6 MM POLYESTER ROPE WITH ONE SOFA 2 SEATERS, TWO ARMCHAIRS AND A TABLE WITH ALUMINIUM TOP. OLEFIN FABRIC CUSHIONS.



CUBA SET

LA LINEA CUBA ESPRIME IL PROPRIO DESIDERIO DI MODERNITÀ ATTRAVERSO LINEE ORIGINALI ED ERGONOMICHE; LA TRAMA DELL'INTRECCIO IN CORDA, INVECE, NE RIVELA LA SFUMATURA TRIBALE. UNA COMMISTIONE TRA DUE MONDI, CHE RIFLETTE LA NATURA DELL'ISOLA DI CUI PORTA IL NOME.

ORIGINAL, ERGONOMIC LINES REVEAL THE CUBA RANGE'S DRIVE FOR MODERNITY, WHILE THE WOVEN ROPE PATTERNS EVOKE TRIBAL IMAGES. THIS MINGLING OF TWO WORLDS REFLECTS THE NATURE OF THE ISLAND THAT GAVE THE SELECTION ITS NAME.

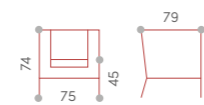

POLTRONA
1 SEATER



TAVOLINO
SMALL TABLE

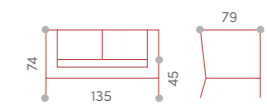

DIVANO 2 POSTI
SOFA 2 SEATERS

CUBA SET

L'INTRECCIO IN CORDA DI POLIESTERE RICORRE NEL SET CUBA. DALLE FORME PIÙ MARCATE E LINEARI, CREA UNA CURVA UNICA TRA BRACCIOLI E SCHIENALE, CHE CONTIENE IL CUSCINO DELLO SCHIENALE CHE SI DISTINGUE PER MORBIDEZZA E VOLUME. I CUSCINI DELLA SEDUTA MANTENGONO UNO STILE GEOMETRICO, LE GAMBE POSTERIORI, PARTICOLARMENTE INCLINATE VERSO L'ESTERNO, GARANTISCONO UNA MAGGIORE SOLIDITÀ DELLA STRUTTURA.

THE POLYESTER ROPE WEAVE ON THE CUBA SET WHICH HAS MORE DISTINCTIVE AND LINEAR FORMS. THE ARMCHAIRS AND THE TWO- OR THREE-SEATER SOFA ARE INSPIRED BY THE DESIGN OF THE POWDER-COATED ALUMINIUM COFFEE TABLE, WHICH HAS SLANTING LEGS LIKE THE OTHER ITEMS. THE CUSHIONS ON THE SEAT HAVE A GEOMETRIC STYLE, WHILE THE DISTINGUISHING FEATURES OF THE ONES ON THE BACKREST ARE THEIR SOFTNESS AND VOLUME.

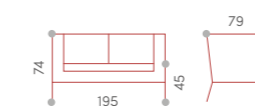

DIVANO 3 POSTI
SOFA 3 SEATERS

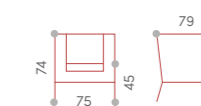

POLTRONA
1 SEATER

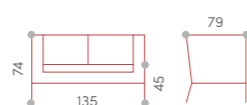

DIVANO 2 POSTI
SOFA 2 SEATERS



TAVOLINO
SMALL TABLE



MINORCA SET

COORDINATO CON STRUTTURA IN ALLUMINIO E RIVESTIMENTO IN CORDA ACRILICA PIATTA, COMPOSTO DA UN DIVANO, DUE POLTRONE E UN TAVOLINO CON PIANO IN VETRO. CUSCINERIA SFODERABILE IN TESSUTO ACRILICO.

ALUMINIUM SET COVERED WITH FLAT ACRYLIC ROPE WITH ONE SOFA, TWO ARMCHAIRS AND A TABLE WITH GLASS TOP. ACRYLIC FABRIC CUSHIONS.

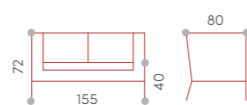

DIVANO 2 POSTI
SOFA 2 SEATERS



TAVOLINO
SMALL TABLE

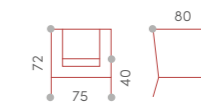

POLTRONA
1 SEATER

KOS SET

COORDINATO CON STRUTTURA IN ALLUMINIO E RIVESTIMENTO IN CORDA POLIESTERE E GOMMA. COMPOSTO DA UN DIVANO 3 POSTI, DUE POLTRONE E UN TAVOLINO CON PIANO IN ALLUMINIO. CUSCINERIA CON GOMMA DRENANTE E TESSUTO ACRILICO.

ALUMINIUM SET COVERED WITH POLYESTER AND RUBBER ROPE WITH ONE SOFA 3 SEATERS, TWO ARMCHAIRS AND ONE COFFEE TABLE WITH ALUMINIUM TOP, FAST DRY FOAM AND ACRYLIC FABRIC CUSHIONS.



KOS SET

È SEMPRE PIACEVOLE ABBANDONARSI IN UN RETICOLO, AVVOLTI DA UNA MAGLIA DI AGGRAZIATE FORME ETEREE E MATERICHE. COMPOSTO DA UN DIVANO 2 O 3 POSTI, DUE POLTRONE E UN TAVOLINO CON PIANO IN ALLUMINIO.

IT IS ALWAYS A PLEASURE TO ABANDON ONESELF IN A LATTICE, WRAPPED IN A MESH OF GRACEFUL ETHEREAL AND MATERIAL FORMS. ALUMINIUM SET COVERED WITH POLYESTER AND RUBBER ROPE WITH ONE SOFA 2 SEATERS, TWO ARMCHAIRS AND ONE COFFEE TABLE WITH ALUMINIUM TOP.

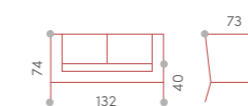

DIVANO 2 POSTI
SOFA 2 SEATERS

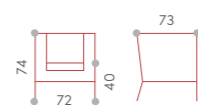

POLTRONA
1 SEATER

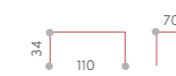

TAVOLINO
SMALL TABLE



CRETA SET

LINEE E ANGOLI TRASMETTONO UN SENTORE DI SOLIDITÀ CHE, A SUA VOLTA, SI CONIUGA IN SICUREZZA: IL SET CRETA, TRAMITE IL SUO CARATTERE DETERMINATO, DIVENTA COSÌ METAFORA DI PROTEZIONE, CHE PERMETTE DI ESSERE SERENI.

LINES AND ANGLES CONVEY A SENSE OF SOLIDITY WHICH, IN TURN, COMBINES IN SAFETY: THE CRETA SET, BY ITS DETERMINED CHARACTER, THUS BECOMES A METAPHOR OF PROTECTION, WHICH ALLOWS YOU TO BE SERENE.

COORDINATO CON STRUTTURA IN ALLUMINIO COMPOSTO DA DUE POLTRONE, UN DIVANO E DUE TAVOLINI CON PIANO IN VETRO CERAMICA. CUSCINERIA SFODERABILE IN TESSUTO SUNPROOF E GOMMA DRENANTE.

ALUMINIUM SET WITH TWO ARMCHAIRS, ONE SOFA AND TWO TABLES WITH CERAMIC GLASS TOP. UPHOLSTERED CUSHIONS WITH SUNPROOF FABRIC AND QUICK DRY FOAM.

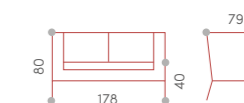

DIVANO 2 POSTI
SOFA 2 SEATERS

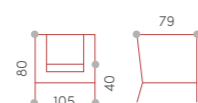

POLTRONA
1 SEATER



TAVOLO
TABLE



TAVOLINO
SMALL TABLE

CRETA SET



FREEDOM SET



FREEDOM SET

COORDINATO COMPOSTO DA DUE PANCHE CON SCHIENALI MOVIBILI ED UN TAVOLINO CON PIANO IN POLYWOOD EFFETTO TEAK. STRUTTURA IN ALLUMINIO E DOGHE IN POLYWOOD. RIVESTIMENTO CON TESSUTO OLEFIN IDROREPELENTE.

LIVING SET WITH TWO BENCHES WITH MOVABLE BACKS AND A COFFEE TABLE WITH POLYWOOD SLATS. ALUMIUM FRAME WITH POLYWOOD SLATS AND UPHOLSTERED WITH OLEFIN WATERPROOF FABRIC.



FREEDOM SET

IL SET FREEDOM È UNA COMPOSIZIONE CHE UNISCE FANTASIA, ESPRESSIONE, SPONTANEITÀ, IL TUTTO SENZA RINUNCIARE ALL'ELEGANZA DEI SUOI ELEMENTI. IL GIOCO TRA GLI SCHIENALI MOVIBILI DELLE PANCHE E IL TAVOLINO CON PIANO IN POLYWOOD E STRUTTURA IN ALLUMINIO, DIVENTA UN CONTINUO DIALOGO TRA CREATIVITÀ E PERSONALITÀ.

THE FREEDOM SET IS A COMPOSITION THAT COMBINES IMAGINATION, EXPRESSION, SPONTANEITY, ALL WITHOUT SACRIFICING THE ELEGANCE OF ITS ELEMENTS. THE GAME BETWEEN THE MOVABLE BACKS OF THE BENCHES AND THE COFFEE TABLE WITH POLYWOOD TOP AND ALUMINUM STRUCTURE, BECOMES A CONTINUOUS DIALOGUE BETWEEN CREATIVITY AND PERSONALITY.



DIVANO 2 POSTI
SOFA 2 SEATERS

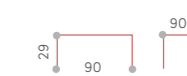

TAVOLINO
SMALL TABLE

IVORY SET

COORDINATO MODULARE IN ALLUMINIO
 COMPOSTO DA DUE DIVANI, UN LINEARE,
 UN ANGOLO E UN TAVOLINO. STRUTTURA IN
 ALLUMINIO, TEAK E GOMMA DRENANTE "FAST DRY
 FOAM", RIVESTIMENTO IN TESSUTO SUNBRELLA.

ALUMINUM AND TEAK MODULAR SET
 UPHOLSTERED WITH FAST DRY FOAM
 AND SUNBRELLA FABRIC, WITH TWO
 SOFAS, ONE MIDDLE SOFA, ONE CORNER
 AND ONE COFFEE TABLE.



IVORY SET

IVORY RIPRENDE LA COMPOSIZIONE ANGOLARE A DUE MODULI DEL SALOTTO ALVORY, AGGIUNGENDO ALLA STRUTTURA IN ALLUMINIO DI SEDUTA E TAVOLINO UN RESISTENTE RIVESTIMENTO IN LEGNO TEAK.

IVORY TAKES THE ALVORY LOUNGE SET'S CORNER COMPOSITION WITH TWO MODULES AND ADDS A DURABLE TEAK COVER TO THE ALUMINIUM FRAME OF THE SEAT AND THE COFFEE TABLE.

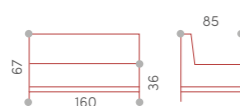

DIVANO 2 POSTI
SOFA 2 SEATERS

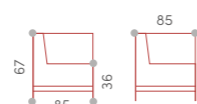

SEDUTA ANGOLARE
CORNER SEATER

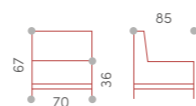
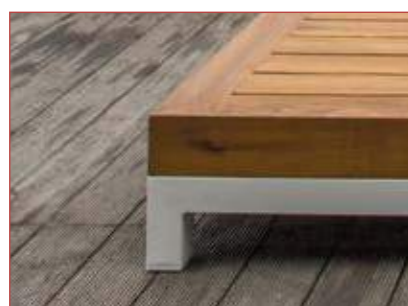

POLTRONA
1 SEATER



TAVOLINO
SMALL TABLE

ALVORY SET

COORDINATO MODULARE COMPOSTO DA DUE DIVANI, UN LINEARE, UN ANGOLO E UN TAVOLINO. STRUTTURA IN ALLUMINIO E GOMMA DRENANTE "FAST DRY FOAM" E RIVESTIMENTO IN TESSUTO SUNBRELLA. ADATTO AD UN USO ESTERNO.

ALUMINIUM MODULAR SET, UPHOLSTERED WITH FAST DRY FOAM AND SUNBRELLA FABRIC, WITH TWO SOFAS, ONE MIDDLE SOFA, ONE CORNER AND TABLE. SUITABLE FOR AN OUTDOOR USE.



ALVORY SET

SALOTTO componibile dal design elegante e contemporaneo. La struttura, che conta un modulo lineare e uno angolare, si compone di un imbottito in schiuma di poliuretano reticolato drenante, rivestito in tessuto SUNBRELLA®.

ALVORY IS A MODULAR LOUNGE SET WITH AN ELEGANT, CONTEMPORARY DESIGN. THE FRAME IS MADE UP OF A CORNER PIECE AND A STRAIGHT PIECE. THE POLYURETHANE FOAM PADDING HAS A DRAINING, GRID-BASED DESIGN AND IT IS COVERED WITH BREATHABLE, WATERPROOF SUNBRELLA® FABRIC.

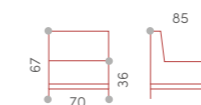

POLTRONA
1 SEATER

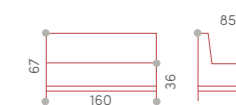

DIVANO 2 POSTI
SOFA 2 SEATERS

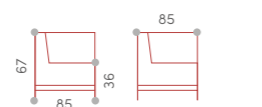

SEDUTA ANGOLARE
CORNER SEATER



TAVOLINO
SMALL TABLE

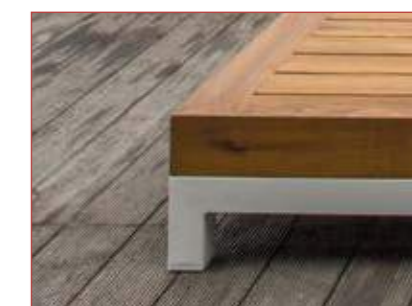

ALVORY SET

I PIEDINI REGOLABILI E IL TELAIO LEGGERO IN ALLUMINIO SI ALLUNGANO OLTRE I LIMITI DELL'IMBOTTITO, ANDANDO A CREARE DUE TAVOLINI LATERALI IN UNA SOVRAPPOSIZIONE DI LIVELLI E FORME. IL COFFEE TABLE, ANCH'ESSO IN ALLUMINIO, RICHIAMA LA LAVORAZIONE A TRAMA ORIZZONTALE DELLA STRUTTURA.

THE ADJUSTABLE FEET AND THE LIGHTWEIGHT ALUMINIUM FRAME EXTEND BEYOND THE PADDED AREA TO FORM TWO SIDE TABLES, PRODUCING A VARIED DISPLAY OF LEVELS AND SHAPES. THE COFFEE TABLE IS ALSO MADE OF ALUMINIUM AND IT REFLECTS THE HORIZONTAL WEAVE PATTERN OF THE FRAME.

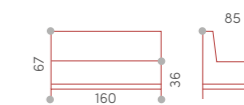

DIVANO 2 POSTI
SOFA 2 SEATERS

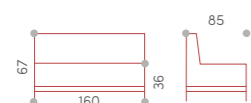

DIVANO 2 POSTI
SOFA 2 SEATERS

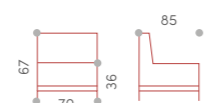

POLTRONA
1 SEATER



TAVOLINO
SMALL TABLE

MONACO SET

COORDINATO IMPILABILE IN ALLUMINIO E RIVESTIMENTO IN CORDA TEXTILENE, COMPOSTO DA UN DIVANO DUE POSTI, DUE POLTRONE E UN TAVOLINO CON PIANO IN ALLUMINIO. CUSCINERIA SFODERABILE IN TESSUTO OLEFIN IDROREPELENTE.

STACKABLE ALUMINIUM. SET COVERED WITH TEXTYLENE ROPE, WITH ONE SOFA 2 SEATERS, TWO ARMCHAIRS AND AN ALUMINIUM COFFEE TABLE. UPHOLSTERED WITH OLEFIN WATERPROOF FABRIC.

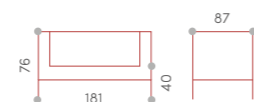

DIVANO 2 POSTI
SOFA 2 SEATERS

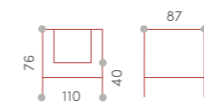

POLTRONA
1 SEATER



92

LETTINI SUNLOUNGER

NEL PASSAGGIO DI STATI
FRA IL SOGNO E LA VEGLIA,
I LETTINI FANNO DA PONTE FRA I
DUE MONDI. SONO FATTI DELLA
STESSA MATERIA DEL RIPOSO E
DEL SONNO; DANNO LA FORMA AL
NOSTRO DESIDERIO DI BELLEZZA.

IN THE JOURNEY BETWEEN
DREAMING AND WAKEFULNESS,
LOUNGERS ACT AS A BRIDGE
BETWEEN THE TWO WORLDS. THEY
ARE MADE OF THE SAME MATTER
AS REST AND SLEEP, GIVING SHAPE
TO OUR DESIRE FOR BEAUTY.



MUSES DAYBED

ABBANDONARSI ALLA QUIETE E AL RELAX È ESSENZIALE PER POTER RICARICARE LE ENERGIE. IL DAYBED DEL SET MUSES È IL LETTINO MATRIMONIALE CHE PERMETTE DI IMMERGERSI NEL COMFORT E AMMIRARE LA NATURA CIRCOSTANTE.

TO INDULGE IN PEACE AND RELAX IS ESSENTIAL TO RECHARGE THE ENERGY. THE DAYBED OF THE MUSES SET IS THE DOUBLE BED THAT ALLOWS YOU TO IMMERSE YOURSELF IN COMFORT AND ADMIRE THE SURROUNDING NATURE.

LETTINO MATRIMONIALE CON STRUTTURA IN ALLUMINIO E RIVESTIMENTO IN CORDA SINTETICA WINTECH. CUSCINERIA SFODERABILE CON TESSUTO OLEFIN IDROREPELLENTE.

ALUMINIUM DAYBED COVERED WITH WINTECH SYNTHETIC ROPE. REMOVABLE CUSHIONS WITH WATER-REPELLENT OLEFIN FABRIC.

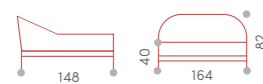

LETTINO
SUNBED

BARI DAYBED

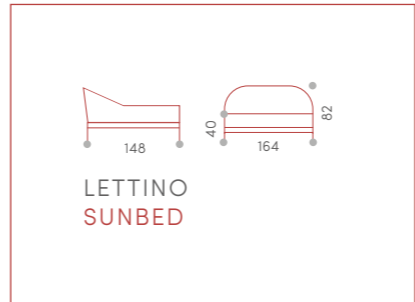

BARI SWING



ALTALENA CON STRUTTURA IN ALLUMINIO E RIVESTIMENTO IN CORDA SINTETICA WINTECH. CUSCINERIA SFODERABILE CON TESSUTO OLEFIN.

ALUMINIUM SWING CHAIR COVERED WITH WINTECH SYNTHETIC ROPE. REMOVABLE CUSHIONS WITH OLEFIN FABRIC.

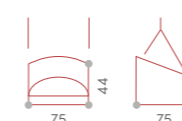

ALTALENA
SWING

BARI ROCKING CHAIR



DONDOLO CON STRUTTURA IN ALLUMINIO E RIVESTIMENTO IN CORDA SINTETICA WINTECH. CUSCINERIA SFODERABILE CON TESSUTO OLEFIN.

ALUMINIUM HANGING CHAIR COVERED WITH WINTECH SYNTHETIC ROPE. REMOVABLE CUSHIONS WITH OLEFIN FABRIC.

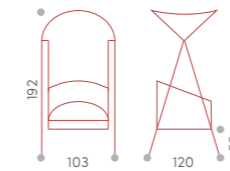

DONDOLO HANGING CHAIR



PANAMA SUNBED

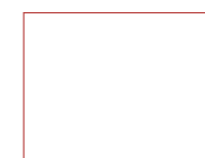

LETTINO IN ALLUMINIO CON
RIVESTIMENTO IN TEXTILENE E GOMMA
CUSCINERIA IN TEXTILENE.

ALUMINIUM SUNBED COVERED
WITH TEXTYLENE AND RUBBER
ROPE. TEXTYLENE CUSHIONS.



PANAMA SUNBED

UN MODO ELEGANTE PER RICHIAMARE LE ATMOSFERE RILASSANTI TIPICHE DEI CARAIBI. IL LETTINO PANAMA NASCE COME UN COLLEGAMENTO TRA IL MONDO DEL RELAX E QUELLO DELLA CONDIVISIONE DI MOMENTI DA TRASCORRERE IN COMPAGNIA. IL TUTTO, ALL'INSEGNA DELLO STILE E DELLA PIACEVOLEZZA.

AN ELEGANT WAY TO INVOKE THE RELAXING ATMOSPHERES OF THE CARIBBEAN. THE PANAMA SUNBED HAS BEEN CREATED AS A CONNECTION BETWEEN THE WORLD OF RELAXATION AND THE WORLD OF SHARING MOMENTS IN COMPANY. EVERYTHING UNDER THE BANNER OF STYLE AND CONGENIALITY.

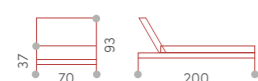

LETTINO
SUNBED



PANAMA DAYBED

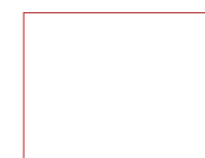

LETTINO MATRIMONIALE IN ALLUMINIO
CON RIVESTIMENTO IN TEXTILENE E
GOMMA. CUSCINERIA IN TEXTILENE.

ALUMINIUM DAYBED COVERED
WITH TEXTYLENE AND RUBBER
ROPE. TEXTYLENE CUSHIONS.



PANAMA DAYBED

LASCIANDOSI CULLARE DALLE SENSAZIONI, IMMERSI NEL COMFORT TOTALE DEL DAYBED PANAMA VENGONO AFFIORANO IMMEDIATAMENTE RICORDI DI MARI LONTANI E DELLA LORO QUIETE. UN ELEMENTO DI DESIGN CHE, CON FORME E MATERIALI RICERCATI, REISCE A FAR VIAGGIARE IL RELAX VERSO LIDI ESOTICI.

ALLOWING YOURSELF BE CRADLED BY SENSATIONS, IMMERSING YOURSELF IN THE TOTAL COMFORT OF THE PANAMA DAYBED, MEMORIES OF DISTANT CALM SEAS COME TO MIND. A DESIGN ELEMENT WHOSE ELEGANT FORMS AND MATERIALS ENABLES YOUR RELAXATION TO WANDER TO EXOTIC LIDOS.

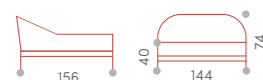

LETTINO
DAYBED



EDEN DAYBED

LE FORME SINUOSE, I MATERIALI RICERCATI E LA POSSIBILITÀ DI SCEGLIERE SE RIPARARSI O ESSERE BACIATI DAL SOLE, RENDONO IL RELAX ALL'APERTO UN PICCOLO ANGOLO DI PARADISO. EDEN UN VERO E PROPRIO GODERE DEL RELAX ALL'ARIA APERTA ANCHE NELLE GIORNATE PIÙ CALDE.

THE SINUOUS SHAPES, THE ELEGANT MATERIALS AND THE POSSIBILITY OF CHOOSING WHETHER TO SEEK SHELTER OR REMAIN UNDER THE SUN, MAKE RELAXING OUTDOORS A SMALL CORNER OF PARADISE. EDEN, AUTHENTIC RELAXATION IN THE OPEN AIR, EVEN ON THE HOTTEST DAYS.

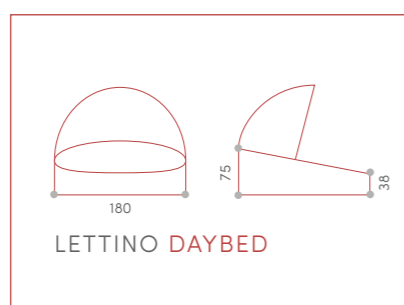

LETTINO DUE POSTI CON STRUTTURA IN ALLUMINIO VERNICIATO E RIVESTIMENTO IN CORDA TEXTILENE E GOMMA. MATERASSO IN TESSUTO IDROREPELLENTE E TENDA PARASOLE RECLINABILE CON TESSUTO ACRILICO.

ALUMINIUM SUNBED COVERED WITH TEXTILENE AND RUBBER ROPE. MATTRESS UPHOLSTERED WITH WATERPROOF FABRIC, ADJUSTABLE TENT WITH ACRYLIC FABRIC.



BITE SUNBED

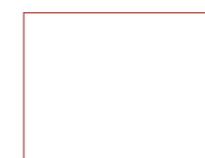

LETTINO CON STRUTTURA IN ALLUMINIO,
GOMMA DRENANTE FAST DRY FOAM E
RIVESTIMENTO IN TESSUTO SUNBRELLA®.
ADATTO AD UN USO ESTERNO.

ALUMINIUM SUNBED UPHOLSTERED
WITH FAST DRY FOAM AND
SUNBRELLA® FABRIC. AVAILABLE FOR
AN OUTDOOR USE.



BITE SUNBED

MINIMAL CHE SI FA MASSIMO NEL COMFORT: IL LETTINO BITE AGGANCIA ALLA PROPRIA STRUTTURA IN ALLUMINIO UNO SPESSO RIVESTIMENTO DRENANTE IN SCHIUMA DI POLIURETANO RETICOLATO. L'IMBOTTITO, DIVISO IN DUE SEZIONI DISTINTE, UNISCE SEDUTA E SCHIENALE ATTRAVERSO UNA ROBUSTA CUCITURA APPLICATA AL TESSUTO SUNBRELLA®.

A MINIMAL DESIGN OFFERING MAXIMUM COMFORT: ATTACHED TO THE ALUMINIUM FRAME OF THE BITE SUN LOUNGER IS THICK POLYURETHANE FOAM PADDING WITH A DRAINING, GRID-BASED DESIGN. IT IS DIVIDED INTO TWO DISTINCT SECTIONS AND THE SEAT AND BACKREST ARE JOINED BY STURDY STITCHING IN THE WATERPROOF SUNBRELLA® FABRIC.

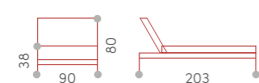

LETTINO
SUNBED



SCHIENALE REGOLABILE
IN QUATTRO ALTEZZE
ADJUSTABLE BACKREST WITH FOUR
DIFFERENT HEIGHTS

BITE ECO SUNBED

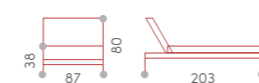

LETTINO
SUNBED

BITE DOUBLE



BITE

DOUBLE SUNBED

MINIMAL CHE SI FA MASSIMO NEL COMFORT: IL LETTINO BITE AGGANCIA ALLA PROPRIA STRUTTURA IN ALLUMINIO UNO SPESSO RIVESTIMENTO DRENANTE IN SCHIUMA DI POLIURETANO RETICOLATO. L'IMBOTTITO, DIVISO IN DUE SEZIONI DISTINTE, UNISCE SEDUTA E SCHIENALE ATTRAVERSO UNA ROBUSTA CUCITURA APPLICATA AL TESSUTO SUNBRELLA®.

A MINIMAL DESIGN OFFERING MAXIMUM COMFORT: ATTACHED TO THE ALUMINIUM FRAME OF THE BITE SUN LOUNGER IS THICK POLYURETHANE FOAM PADDING WITH A DRAINING, GRID-BASED DESIGN. IT IS DIVIDED INTO TWO DISTINCT SECTIONS AND THE SEAT AND BACKREST ARE JOINED BY STURDY STITCHING IN THE WATERPROOF SUNBRELLA® FABRIC.



LETTINO
SUNBED

LETTINO MATRIMONIALE CON STRUTTURA IN ALLUMINIO, GOMMA DRENANTE FAST DRY FOAM E RIVESTIMENTO IN TESSUTO SUNBRELLA®. ADATTO AD UN USO ESTERNO.

DOUBLE ALUMINIUM SUNBED UPHOLSTERED WITH FAST DRY FOAM AND SUNBRELLA® FABRIC. AVAILABLE FOR AN OUTDOOR USE.



JOY SUNBED

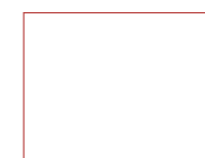

LETTINO CON STRUTTURA IN ALLUMINIO,
GOMMA DRENANTE FAST DRY FOAM E
RIVESTIMENTO IN TESSUTO SUNBRELLA®.
ADATTO AD UN USO ESTERNO.

ALUMINIUM SUNBED UPHOLSTERED
WITH FAST DRY FOAM AND
SUNBRELLA® FABRIC. AVAILABLE FOR
AN OUTDOOR USE.



JOY SUNBED

QUANDO TUTTO È A PORTATA DI MANO RIMANE SOLO UNA COSA DA FARE. LASCIARSI ANDARE CONSERVANDO SEMPRE LA GIOIA DI QUESTI MOMENTI.

WHEN EVERYTHING IS CLOSE AT HAND, THERE IS ONLY ONE THING LEFT TO DO. LET YOURSELF GO, ALWAYS PRESERVING THE JOY OF THESE MOMENTS.

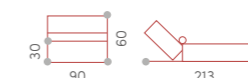

LETTINO
SUNBED

LETTINO CON STRUTTURA IN ALLUMINIO, GOMMA DRENANTE FAST DRY FOAM E RIVESTIMENTO IN TESSUTO SUNBRELLA®. ADATTO AD UN USO ESTERNO.

ALUMINIUM SUNBED UPHOLSTERED WITH FAST DRY FOAM AND SUNBRELLA® FABRIC. AVAILABLE FOR AN OUTDOOR USE.



ANTIGUA DAYBED

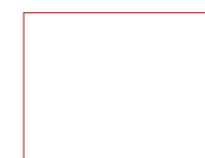

LETTINO DUE POSTI CON STRUTTURA IN ALLUMINIO VERNICIATO, MATERASSO IN ECOPELLE NAUTICA, IDROREPELLENTE. SCHIENALE RECLINABILE IN 5 POSIZIONI E TENDA REGOLABILE.

ALUMINIUM DAYBED WITH PU MATTRESS, WATER REPELLENT. ADJUSTABLE BACK WITH 5 POSITIONS AND ADJUSTABLE TENTS.



ANTIGUA LUX DAYBED

ANTIGUA SEMBRA RACCHIUDERE ALL'INTERNO DEL PROPRIO BALDACCHINO LA VERA ESSENZA DELL'OZIO. MORBIDI IMBOTTITI DALLE MISURE GENEROSE PERMETTONO DI CONDIVIDERE MOMENTI DI RELAX NELLA RISERVATEZZA DI UNA CASCATA DI TENDE.

THE VERY ESSENCE OF EASE SEEMS TO BE EMBODIED BY ANTIGUA. SOFT, SIZEABLE PADDING PROVIDES THE PERFECT PLACE FOR RELAXING AND ENJOYING THE PRIVACY BEHIND THE CASCADING CURTAINS.



LETTINO DUE POSTI CON STRUTTURA IN ALLUMINIO VERNICIATO, MATERASSO IN ECOPELLE NAUTICA, IDROREPELENTE. SCHIENALE RECLINABILE IN 5 POSIZIONI E TENDA REGOLABILE.

ALUMINIUM DAYBED WITH PU MATTRESS, WATER REPELLENT, ADJUSTABLE BACK WITH 5 POSITIONS AND ADJUSTABLE TENTS.

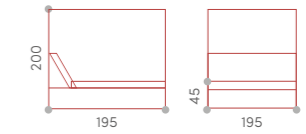

SCHIENALE REGOLABILE IN CINQUE POSIZIONI
DOPPIA TENDA IN POLIESTERE REGOLABILE

ADJUSTABLE BACKREST WITH FIVE
DIFFERENT POSITIONS
ADJUSTABLE DOUBLE POLYESTER CURTAIN



GS924 LUX SUNBED

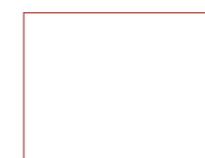

LETTINO CON STRUTTURA IN ALLUMINIO,
SEDUTA E SCHIENALE IN TEXTILENE E
SCHIUMA. SPESSORE TUBO 2,00 MM.

SUNBED ALUMINIUM FRAME,
SEAT AND BACK IN TEXTYLENE
AND FOAM. THICKNESS 2,00 MM.



GS924 LUX SUNBED

CON IL SUO STILE MODERNO, COSÌ LINEARE ED ESSENZIALE, GS 924 LUX È IN GRADO DI DONARE ORIGINALITÀ AI DIVERSI AMBIENTI. LA FUNZIONALITÀ È AL SERVIZIO DEL DESIGN, ESALTANDO AL MASSIMO TUTTE LE PECULIARITÀ DI UN RELAX CHE ACCOMPAGNERÀ CON ARMONIA E BELLEZZA I MOMENTI DELLA GIORNATA.

WITH ITS MODERN STYLE, THOROUGHLY LINEAR AND MINIMAL, GS 924 LUX CAN GIVE A TOUCH OF ORIGINALITY TO DIVERSE ENVIRONMENTS. FUNCTIONALITY IS AT THE SERVICE OF DESIGN, MAXIMISING ALL THE PARTICULARITIES OF A RELAXATION THAT WILL ACCOMPANY THE MOMENTS OF THE DAY WITH HARMONY AND BEAUTY.

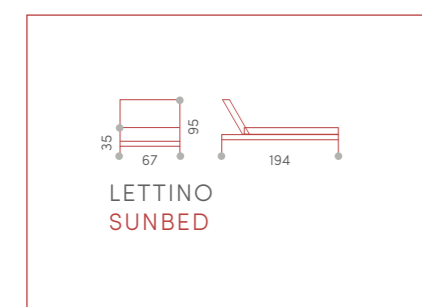

GS927 SUNBED

COMPATTEZZA, EQUILIBRIO, SIMMETRIA E LEGGEREZZA SONO LA BASE E AL TEMPO IL FULCRO DI QUESTO LETTINO. GS 927, CON LE SUE FATTEZZE, GUARDA AL FUTURO SENZA DIMENTICARE LA TRADIZIONE. UN ESEMPIO PERFETTO DI COME SIANO I DETTAGLI A FARE LA DIFFERENZA QUANDO SI TRATTA DI ESALTARE TUTTE LE SFUMATURE DI UN AMBIENTE ESTERNO.

COMPACTNESS, BALANCE, SYMMETRY AND LIGHTNESS ARE THE BASE AND AT THE SAME TIME THE CENTRE OF THIS DAYBED. GS 927, WITH ALL ITS FEATURES, LOOKS TO THE FUTURE WITHOUT FORGETTING TRADITION. A PERFECT EXAMPLE OF HOW DETAILS MAKE THE DIFFERENCE WHEN IT COMES TO ENHANCING ALL THE NUANCES OF AN OUTDOOR ENVIRONMENT.

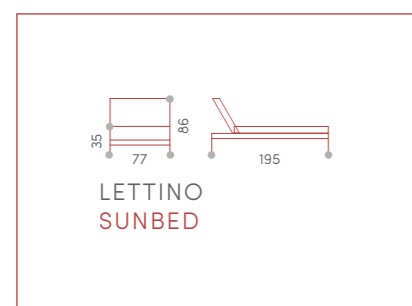
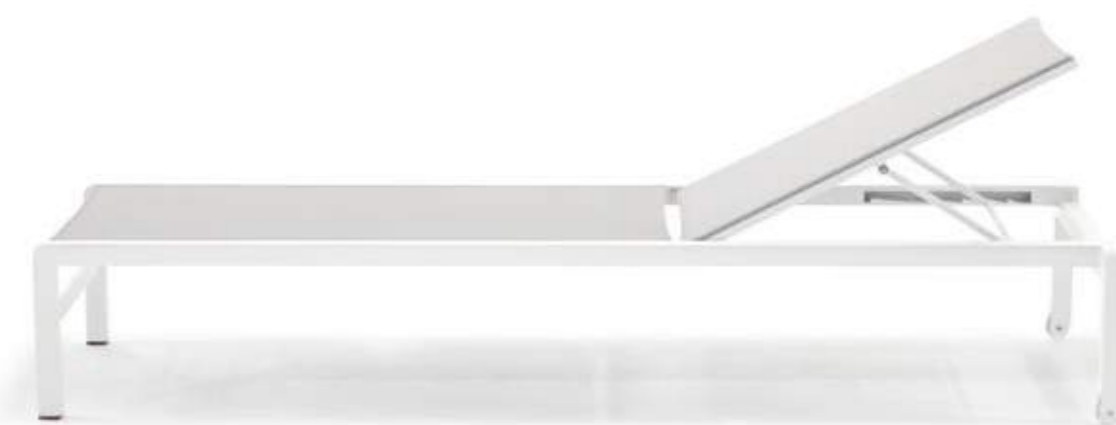

LETTINO IMPILABILE CON STRUTTURA IN ALLUMINIO VERNICIATO, SCHIENALE E SEDUTA IN TEXTILENE, SPESSORE TUBO 2,0 MM.

STACKABLE SUNBED ALUMINIUM FRAME, SEAT AND BACK IN TEXTILENE, THICKNESS MM 2,0.



GS927 SUNBED



GS926 SUNBED

COMPATTEZZA, EQUILIBRIO, SIMMETRIA E LEGGEREZZA SONO LA BASE E AL CONTEMPO IL FULCRO DI QUESTO LETTINO. CON LE SUE FATTEZZE, GUARDA AL FUTURO SENZA DIMENTICARE LA TRADIZIONE. UN ESEMPIO PERFETTO DI COME SIANO I DETTAGLI A FARE LA DIFFERENZA QUANDO SI TRATTA DI ESALTARE TUTTE LE SFUMATURE DI UN AMBIENTE ESTERNO.

COMPACTNESS, BALANCE, SYMMETRY AND LIGHTNESS ARE THE BASE AND AT THE SAME TIME THE CENTRE OF THIS SUNBED. WITH ALL ITS FEATURES, LOOKS TO THE FUTURE WITHOUT FORGETTING TRADITION. A PERFECT EXAMPLE OF HOW DETAILS MAKE THE DIFFERENCE WHEN IT COMES TO ENHANCING ALL THE NUANCES OF AN OUTDOOR ENVIRONMENT.

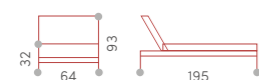

LETTINO
SUNBED

LETTINO IMPILABILE CON STRUTTURA IN ALLUMINIO VERNICIATO, SCHIENALE E SEDUTA IN TEXTILENE, SPESSORE TUBO 2,0 MM.

STACKABLE SUNBED ALUMINIUM FRAME, SEAT AND BACK IN TEXTILENE, THICKNESS MM 2,0.



GS928 BEACH CHAIR

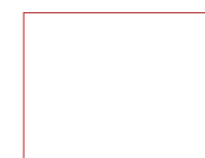

SDRAIO CON STRUTTURA ALLUMINIO,
SCHIENALE E SEDUTA IN TEXTILENE,
SPESORE 2,0 MM.

BEACH CHAIR ALUMINIUM
FRAME, SEAT AND BACK IN
TEXTILENE, THICKNESS MM 2,0.



GS928 BEACH CHAIR

LINEARITÀ ED ESSENZIALITÀ COME ELEMENTI PER RIUSCIRE A RAGGIUNGERE UNO STATO DI PERFETTA ARMONIA. COME PER LO YIN E LO YANG, LO SDRAIO GS 928 UNISCE IN SÉ DESIGN E FUNZIONALITÀ, RESISTENZA E COMODITÀ. CAMBIANDONE LA REGOLAZIONE DELLO SCHIENALE OGNUNO POTRÀ TROVARE L'EQUILIBRIO CHE RICERCA.

LINEARITY AND MINIMALISM AS ELEMENTS FOR REACHING A STATE OF PERFECT HARMONY. AS WITH YIN AND YANG, THE GS 928 LOUNGER COMBINES DESIGN AND FUNCTIONALITY, STRENGTH AND COMFORT. BY ADJUSTING THE BACKREST, EVERYONE WILL FIND THE BALANCE THEY ARE SEEKING.

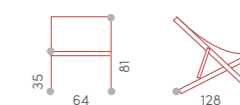

SDRAIO
BEACH CHAIR



142

SEDIE CHAIRS

SEDUTE PER RILASSARSI,
VIAGGIARE CON LA MENTE
VERSO TERRITORI ESOTICI,
LONTANI, VERSO ISOLE DESERTE
NEL MARE PER SCOPRIRE E
RITROVARSI NUOVAMENTE FRA GLI
OGGETTI PIÙ FAMILIARI,
QUELLI INTRECCIATI CON LA VITA
DI TUTTI I GIORNI.

SEATS FOR RELAXING IN,
TRAVELLING WITH THE MIND
TO EXOTIC PLACES, FAR AWAY,
TO DESERT ISLANDS IN THE SEA,
TO DISCOVER AND FIND ONESELF
AGAIN AMONG THE MOST FAMILIAR
OBJECTS, THOSE INTERTWINED
WITH EVERYDAY LIFE.



BARI CHAIR

POLTRONCINA CON STRUTTURA IN ALLUMINIO E RIVESTIMENTO IN CORDA SINTETICA WINECH. CUSCINERIA SFODERABILE CON TESSUTO OLEFIN.

ALUMINIUM ARMCHAIR COVERED WITH WINECH SYNTHETIC ROPE. REMOVABLE CUSHIONS WITH OLEFIN FABRIC.



BARI CHAIR

CIRCONDARSI DI BELLEZZA PERMETTE DI VIVERE DI BELLEZZA. QUESTO TRASPARE DAL SET BARI, METAFORA DI UNO STILE UNICO, CHE RIPORTA ALLE SERATE TRASCORSE IN UN CONNUBIO DI RELAX E CONVIVIO.

SURROUNDING YOURSELF WITH BEAUTY, ALLOWS YOU TO LIVE OF BEAUTY. THIS SHINES THROUGH THE BARI SET, A METAPHOR OF A UNIQUE STYLE, WHICH BRINGS BACK TO THE EVENINGS SPENT IN A COMBINATION OF RELAX AND CONVIVIALITY.

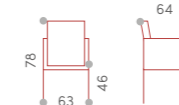

MUSES CHAIR

POLTRONCINA CON STRUTTURA IN ALLUMINIO E RIVESTIMENTO IN CORDA SINTETICA WINTECH. CUSCINERIA SFODERABILE CON TESSUTO OLEFIN.

ALUMINIUM ARMCHAIR COVERED WITH WINTECH SYNTHETIC ROPE. REMOVABLE CUSHIONS WITH OLEFIN FABRIC.

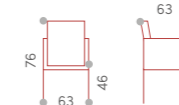

PANAMA CHAIR

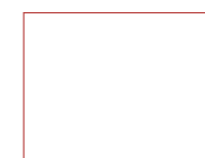

POLTRONCINA IMPILABILE IN ALLUMINIO
CON RIVESTIMENTO IN TEXTILENE E GOMMA.
CUSCINERIA IN TESSUTO ACRILICO.

ALUMINIUM STACKABLE ARMCHAIR
COVERED WITH TEXTYLENE AND RUBBER
ROPE. ACRYLIC CUSHIONS.



PANAMA CHAIR

NEGLI ATTIMI DI STACCO DALLA FRENESIA E DALLA ROUTINE DELLA VITA, UNA SEDUTA CHE ARMONIZZI, RIALLINEI E RICOMPONGA L'ORDINE È LA BENVENUTA NEI NOSTRI SPAZI QUOTIDIANI. PANAMA CALZA, COME UN COMODO CAPPELLO.

IN THE MOMENTS OF DETACHMENT FROM LIFE'S FRENZY AND ROUTINE, A SEAT WHICH HARMONISES, RE-ALIGNS AND RECOMPOSES ORDER IS WELCOME IN OUR EVERYDAY SPACES. PANAMA FITS LIKE A COMFORTABLE HAT.



POLTRONCINA IMPILABILE IN ALLUMINIO CON RIVESTIMENTO IN TEXTILENE E GOMMA. CUSCINERIA IN TEXTILENE.

ALUMINIUM STACKABLE ARMCHAIR COVERED WITH TEXTYLENE AND RUBBER ROPE. TEXTYLENE CUSHIONS.

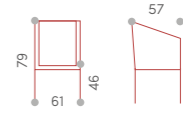

PANAMA STOOL

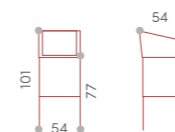

SGABELLO IN ALLUMINIO
CON RIVESTIMENTO IN TEXTILENE
E GOMMA.
CUSCINERIA IN TEXTILENE.

ALUMINIUM BARSTOOL COVERED
WITH TEXTYLENE AND RUBBER ROPE.
TEXTYLENE CUSHIONS.



TAHITI CHAIR

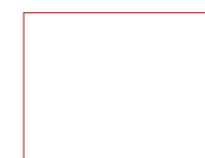

POLTRONCINA IMPILABILE IN ALLUMINIO
CON RIVESTIMENTO IN TESSUTO ACRILICO.
CUSCINERIA IN TESSUTO OLEFIN.

ALUMINIUM STACKABLE ARMCHAIR
COVERED WITH POLYOLEFIN ROPE.
OLEFIN CUSHION.



TAHITI CHAIR

APPENA SEDUTI L'AMBIENTAZIONE CAMBIA. IN UN VIAGGIO SPAZIO-TEMPORALE E SENSORIALE CI SI RITROVA IMMEDIATAMENTE CATAPULTATI SU UN'ISOLA ESOTICA E LONTANA. DOVE IL TEMPO È QUASI SOSPESO E SCORRE LENTO SORSEGGIANDO E CHIACCHIERANDO.

AS SOON AS YOU SIT DOWN, THE MOOD CHANGES. IN A SPACE-TIME AND SENSORIAL JOURNEY, YOU IMMEDIATELY FIND YOURSELF CATAPULTED TO AN EXOTIC AND DISTANT ISLAND. WHERE TIME IS ALMOST SUSPENDED AND PASSES SLOWLY, WHILE ENJOYING A DRINK AND CHATTING.

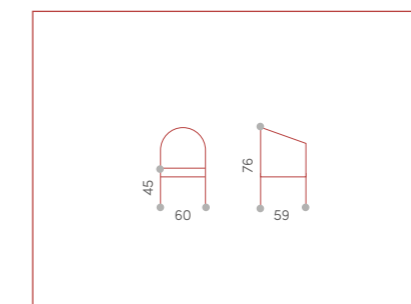

TAHITI CHAIR

APPENA SEDUTI L'AMBIENTAZIONE CAMBIA. IN UN VIAGGIO SPAZIO-TEMPORALE E SENSORIALE CI SI RITROVA IMMEDIATAMENTE CATAPULTATI SU UN'ISOLA ESOTICA E LONTANA. DOVE IL TEMPO È QUASI SOSPESO E SCORRE LENTO SORSEGGIANDO E CHIACCHIERANDO.

AS SOON AS YOU SIT DOWN, THE MOOD CHANGES. IN A SPACE-TIME AND SENSORIAL JOURNEY, YOU IMMEDIATELY FIND YOURSELF CATAPULTED TO AN EXOTIC AND DISTANT ISLAND. WHERE TIME IS ALMOST SUSPENDED AND PASSES SLOWLY, WHILE ENJOYING A DRINK AND CHATTING.

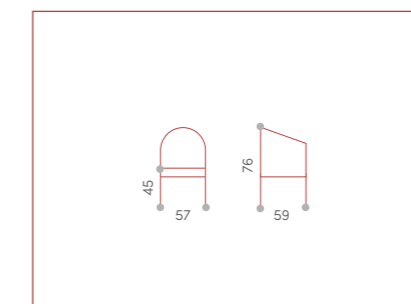

TAHITI STOOL

SGABELLI IMPILABILI IN ALLUMINIO CON CUSCINERIA IN TESSUTO OLEFIN E RIVESTIMENTO IN TESSUTO POLYOLEFIN. MATERIALI GRADEVOLI AL TATTO E DALL'ALTO TASSO DI ELEGANZA, DAI COLORI INTENSI E DECISI.

STACKABLE ALUMINIUM STOOLS WITH CUSHIONS MADE OF OLEFIN FABRIC AND UPHOLSTERY MADE OF POLYOLEFIN FABRIC. MATERIALS THAT ARE PLEASANT TO THE TOUCH AND EXTREMELY ELEGANT, WITH INTENSE AND VIBRANT COLOURS.

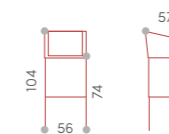

TAHITI STOOL

POLTRONCINE E SGABELLI IMPILABILI IN ALLUMINIO CON CUSCINERIA IN TESSUTO OLEFIN E RIVESTIMENTO IN TESSUTO POLYOLEFIN. MATERIALI GRADEVOLI AL TATTO E DALL'ALTO TASSO DI ELEGANZA, DAI COLORI INTENSI E DECISI.

STACKABLE ALUMINIUM ARMCHAIRS AND STOOLS WITH CUSHIONS MADE OF OLEFIN FABRIC AND UPHOLSTERY MADE OF POLYOLEFIN FABRIC. MATERIALS THAT ARE PLEASANT TO THE TOUCH AND EXTREMELY ELEGANT, WITH INTENSE AND VIBRANT COLOURS.

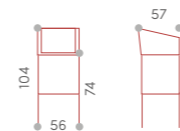

KOS CHAIR

IL BELLO È SUSCITARE IL SENSO DELL'ARMONIA DAGLI OGGETTI D'ARREDO DANDO SIGNIFICATI INEDITI ALL'IRREGOLARITÀ NELLA REGOLARITÀ E VALORIZZANDO L'ASIMMETRIA DELLE FORME. DOVE TELAIO E TESSUTO CONVIVONO RISPETTANDO CIASCUNO IL PROPRIO EQUILIBRIO.

ITS BEAUTY IS IN EVOKING THE SENSE OF HARMONY FROM FURNISHINGS, GIVING UNPRECEDENTED MEANINGS TO IRREGULARITY IN REGULARITY AND ENHANCING THE ASYMMETRY OF THE FORMS. WHERE FRAME AND FABRIC COEXIST, RESPECTING EACH OTHER'S BALANCE.

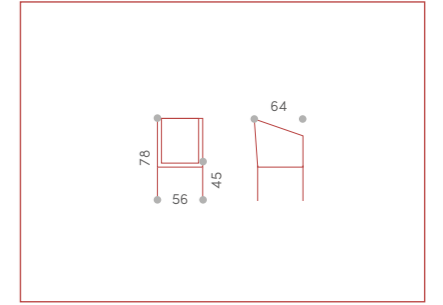

KOS ROCKING CHAIR

RIVESTIMENTO IN CORDA POLIESTERE E GOMMA CON CUSCINERIA DRENANTE E TESSUTO ACRILICO. IL DONDOLO KOS GIOCA CON LE CROMIE, LE EMOZIONI E IL CALORE TIPICO DI UN AVVINCENTE PAESAGGIO DEL MAR MEDITERRANEO. COME UNA PERSONALE CULLA ADAGIATA SULLA SPIAGGIA DI UN'ISOLA DESERTA.

POLYESTER ROPE AND RUBBER UPHOLSTERY WITH DRAINAGE CUSHIONS AND ACRYLIC FABRIC. THE KOS ROCKING CHAIR PLAYS WITH THE COLOURS, EMOTIONS AND WARMTH OF A CAPTIVATING MEDITERRANEAN LANDSCAPE. LIKE A PERSONAL CRADLE RESTING ON THE BEACH OF A DESERT ISLAND.

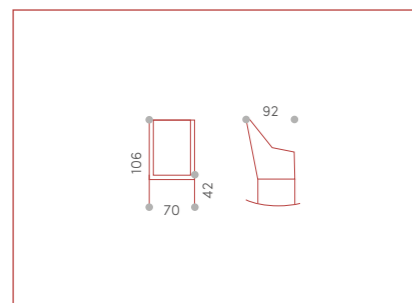

DONDOLO IN ALLUMINIO CON RIVESTIMENTO IN CORDA POLIESTERE E GOMMA. CUSCINERIA DRENANTE E TESSUTO ACRILICO.

ALUMINIUM ROCKING ARMCHAIR WEAVED WITH POLYESTER AND RUBBER ROPE. FAST DRY FOAM CUSHIONS, POLYESTERE FABRIC.



ATOL CHAIR

ATOL HA UNA STRUTTURA IN ALLUMINIO CON UN RIVESTIMENTO IN CORDA ACRILICA E UNA CUSCINERIA IN TESSUTO ACRILICO. LE SEDUTE PIÙ ALTE, NEGLI AMBIENTI GIUSTI, PERMETTONO UN RELAX MORDI E FUGGI E UNO STILE DI VITA MOLTO SMART E BRIOSO.

ATOL HAS AN ALUMINIUM STRUCTURE WITH AN ACRYLIC ROPE COVERING AND AN ACRYLIC FABRIC CUSHION. THE HIGHER SEATS, IN THE RIGHT ENVIRONMENTS, PROVIDE "HIT AND RUN" RELAXATION AND A VERY SMART AND LIVELY LIFESTYLE.

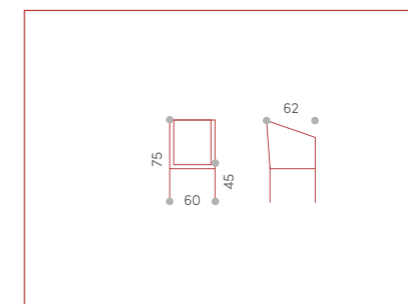

POLTRONCINA IMPILABILE IN ALLUMINIO VERNICIATO CON RIVESTIMENTO IN CORDA ACRILICA. CUSCINO SFODERABILE, TESSUTO OLEFIN.

ALUMINIUM STACKABLE ARMCHAIR COVERED WITH ACRYLIC ROPE. UPHOLSTERED CUSHION WITH OLEFIN FABRIC.



ATOL CHAIR



CUBA CHAIR

L'INTRECCIO IN CORDA DI POLIESTERE DELLA POLTRONCINA CUBA CREA UNA CURVA UNICA TRA BRACCIOLI E SCHIENALE, CHE CONTIENE IL CUSCINO IN GOMMA E TESSUTO ACRILICO, SFODERABILE E ANTIMACCHIA, DELLA SEDUTA.

THE POLYESTER ROPE WEAVE ON THE CUBA ARMCHAIR CREATES A UNIQUE CURVING FORM BETWEEN THE ARMRESTS AND THE BACKREST, ENCLOSING THE RUBBER SEAT CUSHION WITH A STAIN-RESISTANT, REMOVABLE ACRYLIC FABRIC COVER.

LE GAMBE POSTERIORI, PARTICOLARMENTE INCLINATE VERSO L'ESTERNO, DANNO UNA MAGGIORE SOLIDITÀ DELLA STRUTTURA IN ALLUMINIO VERNICIATO A POLVERI.

THE BACK LEGS SIGNIFICANTLY SLANT OUTWARDS AND GIVE GREATER SOLIDITY TO THE POWDER-COATED ALUMINIUM FRAME.



POLTRONCINA IN ALLUMINIO VERNICIATO CON CORDA POLIESTERE Ø 6MM. CUSCINO SFODERABILE, TESSUTO OLEFIN.

ALUMINIUM ARMCHAIR WEAVED WITH POLYESTERE ROPE. UPHOLSTERED CUSHION WITH OLEFIN FABRIC.

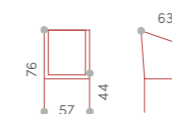

CUBA CHAIR

LE GAMBE POSTERIORI, PARTICOLARMENTE INCLINATE VERSO L'ESTERNO, DANNO UNA MAGGIORE SOLIDITÀ DELLA STRUTTURA IN ALLUMINIO VERNICIATO A POLVERI.

THE BACK LEGS SIGNIFICANTLY SLANT OUTWARDS AND GIVE GREATER SOLIDITY TO THE POWDER-COATED ALUMINIUM FRAME.



POLTRONCINA IN ALLUMINIO VERNICIATO CON CORDA POLIESTERE Ø 6 MM. CUSCINO SFODERABILE, TESSUTO OLEFIN.

ALUMINIUM ARMCHAIR WEAVED WITH POLYESTERE ROPE. UPHOLSTERED CUSHION WITH OLEFIN FABRIC.

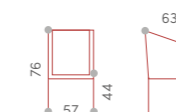

COMO CHAIR

SEDIA CON STRUTTURA IN ALLUMINIO E
RIVESTIMENTO IN CORDA POLIESTERE.
CUSCINERIA SFODERABILE CON TESSUTO OLEFIN.

ALUMINIUM CHAIR COVERED WITH
POLYESTER ROPE. REMOVABLE
CUSHIONS WITH OLEFIN FABRIC



COMO CHAIR

LA STRUTTURA IN ALLUMINIO, RIVESTITA IN CORDA, DEL SET COMO, DONA UN EFFETTO DECISO ALL'AMBIENTE: TRAMITE QUESTO MINIMALISMO ESTETICO, VIENE RICHIAMATA UN'ATMOSFERA DI CLASSE E RICERCATEZZA.

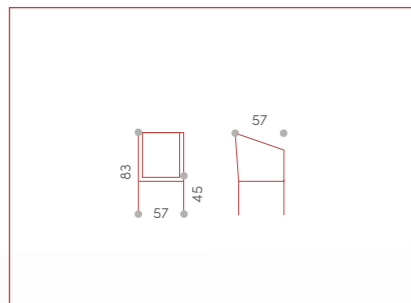

THE ALUMINIUM STRUCTURE, COVERED IN ROPE, OF THE COMO SET, GIVES A DECISIVE EFFECT TO THE ENVIRONMENT: THROUGH THIS MINIMALISTIC AESTHETIC AN ATMOSPHERE OF CLASS AND REFINEMENT IS RECALLED.

SEDIA CON STRUTTURA IN ALLUMINIO E RIVESTIMENTO IN CORDA POLIESTERE. CUSCINERIA SFODERABILE CON TESSUTO OLEFIN.

ALUMINIUM CHAIR COVERED WITH POLYESTER ROPE. REMOVABLE CUSHIONS WITH OLEFIN FABRIC.



COMO LOUNGE

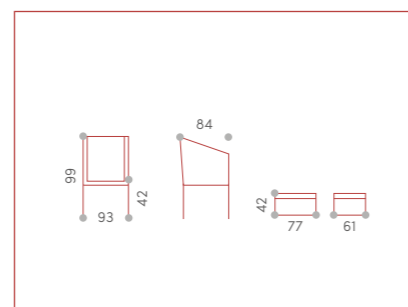

POLTRONA LOUNGE E POGGIPIEDI CON STRUTTURA IN ALLUMINIO E RIVESTIMENTO IN CORDA POLIESTERE. CUSCINERIA SFODERABILE CON TESSUTO OLEFIN.

ALUMINIUM LOUNGE CHAIR AND FOOTREST COVERED WITH POLYESTER ROPE. REMOVABLE CUSHIONS WITH OLEFIN FABRIC.



BAHZA LOUNGE

SE SI INTRECCIANO PRATICITÀ E CLASSE, IL RISULTATO SARÀ UN PRODOTTO UNICO NEL SUO GENERE. È COSÌ CHE NASCE BAHZA LOUNGE, LA SEDIA SMONTABILE IN ALLUMINIO CON RIVESTIMENTO IN CORDA E CUSCINO SFODERABILE, CAPACE DI TRASFORMARE L'AMBIENTE CON LA SUA VERSATILITÀ.

IF PRACTICALITY AND CLASS ARE INTERTWINED, THE RESULT WILL BE A UNIQUE PRODUCT. THIS IS HOW THE BAHZA LOUNGE WAS BORN, THE REMOVABLE ALUMINIUM CHAIR WITH ROPE COVER AND REMOVABLE CUSHION, CAPABLE OF TRANSFORMING THE ENVIRONMENT WITH ITS VERSATILITY.

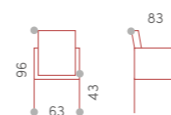

SEDDIA SMONTABILE IN ALLUMINIO VERNICIATO CON RIVESTIMENTO IN CORDA ACRILICA CON TRATTAMENTO TEFLON. CUSCINO SFODERABILE, CON TESSUTO ACRILICO.

ALUMINIUM KD CHAIR COVERED WITH ACRYLIC ROPE TEFLON TREATED. UPHOLSTERED CUSHION WITH ACRYLIC FABRIC.



NANCY LOUNGE

IL SEGRETO PER SAPERSI DISTINGUERE È AVERE PERSONALITÀ. NANCY LOUNGE È SINONIMO DI UN CARATTERE DECISO, CHE RIESCE A VIVERE LA CONVIVIALITÀ CON GUSTO, CREANDO UN'ATMOSFERA VIVA E VIBRANTE.

THE SECRET TO STANDING OUT IS TO HAVE PERSONALITY. NANCY LOUNGE IS SYNONYMOUS WITH A STRONG CHARACTER, WHICH MANAGES TO LIVE CONVIVIALITY WITH TASTE, CREATING A LIVELY AND VIBRANT ATMOSPHERE.

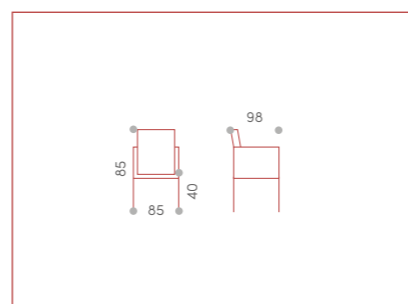

SEDIA LOUNGE IMPILABILE
CON STRUTTURA IN ALLUMINIO
E RIVESTIMENTO IN CORDA
POLIESTERE. CUSCINERIA
SFODERABILE CON TESSUTO
OLEFIN.

STACKABLE ALUMINIUM LOUNGE
CHAIR COVERED WITH POLYESTER
ROPE. REMOVABLE CUSHIONS
WITH OLEFIN FABRIC.



MONACO CHAIR

MONACO È LA POLTRONCINA ERGONOMICA DAL DESIGN LEGGERO CHE RICHIAMA NATURALMENTE ALL'OUTDOOR. LO SCHIENALE SI FONDE CON I BRACCIOLI IN UN INTRECCIO DALL'EFFETTO CORDA, REALIZZATO CON FILAMENTI DI POLIETILENE RICOPERTI DA TEXTILENE; BINOMIO CHE NE ASSICURA ROBUSTEZZA E DURATA.

MONACO IS AN ERGONOMIC ARMCHAIR WITH A LIGHT DESIGN THAT IS A NATURAL MATCH FOR OUTDOOR ENVIRONMENTS. THE BACKREST FUSES WITH THE ARMRESTS IN A WOVEN ROPE EFFECT PRODUCED WITH FILAMENTS OF POLYTHENE COVERED WITH TEXTELINE: A STURDY, DURABLE PAIRING.

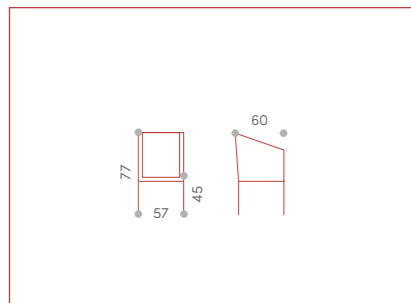

LA STRUTTURA IN ALLUMINIO VERNICIATO A POLVERI ACCOGLIE IL CUSCINO IN GOMMA, RIVESTITO IN TESSUTO OLEFIN SFODERABILE, ANTIMACCHIA E ANTI UV, CHE PUÒ ESSERE RIMOSSO PER IMPILARE LE POLTRONCINE.

ON TOP OF THE POWDER-COATED ALUMINIUM FRAME IS A RUBBER CUSHION WITH A STAIN-RESISTANT, UV-RESISTANT REMOVABLE OLEFIN FABRIC COVER. IF THE CUSHIONS ARE REMOVED, THE ARMCHAIRS CAN BE STACKED.



CANNES CHAIR

TELAIO IN METALLO ZINCATO A FREDDO IMPILABILE.

COLD-GALVANIZED METAL FRAME STACKABLE.

IL SEGRETO DELL'ELEGANZA È LA SEMPLICITÀ. LE SEDUTE CANNES FANNO DI QUESTO INSEGNAMENTO LA PROPRIA PREROGATIVA: LE STRUTTURE SOBRIE E LINEARI COLTIVANO UN FASCINO INTRAMONTABILE; IL FITTO E PRECISO INTRECCIO DELLE SEDUTE IL DETTAGLIO CHE LE FA SPICCCARE.

THE SECRET TO ELEGANCE IS SIMPLICITY. THIS CONCEPT IS AT THE HEART OF THE CANNES SEATS: THE UNDERSTATED, LINEAR FRAMES ARE STEEPED IN TIMELESS APPEAL, WHILE THE THICK, PRECISE WEAVE DETAILING ON THE SEATS ADDS A DISTINCTIVE TOUCH.

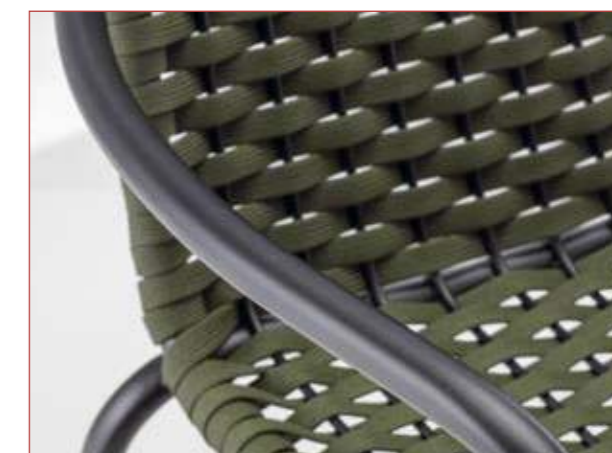
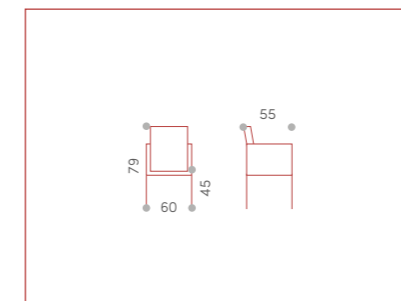

CANNES LUX CHAIR

LA POLTRONCINA CANNES SI ARRICCHISCE DI UN ULTERIORE INTRECCIO NELLA SUA VERSIONE LUX. LA RIGIDITÀ DELLA STRUTTURA IN METALLO ZINCATO A FREDDO COLOR ANTRACITE, CONTRASTA CON LA MORBIDEZZA DI SEDUTA E SCHIENALE IN GOMMA RIVESTITA DI POLIESTERE COLOR MARRONE. COME NELLA VERSIONE IN TEXTILENE, LA STRUTTURA È IMPILABILE.

INTRECCIO IN GOMMA RIVESTITA DI POLIESTERE.
RUBBER AND POLYESTER WEAVE.

THE LUX VERSION OF THE CANNES ARMCHAIR BOASTS AN ADDITIONAL WEAVE. THE SOLID COLD-GALVANIZED METAL FRAME IN AN ANTHRACITE SHADE CONTRASTS WITH THE SOFT RUBBER SEAT AND BACKREST COVERED WITH BROWN POLYESTER. LIKE THE TEXTELINE VERSION, IT HAS A STACKABLE FRAME.

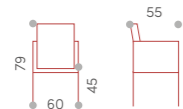

CANNES STOOL

LO SGABELLO CANNES FA DELL'ESSENZIALITÀ IL SUO PUNTO DI FORZA. LA STRUTTURA IMPILABILE, IN METALLO INCONTRA LA TRAMA IN TEXTILENE E POLIETILENE. L'ASSENZA DI BRACCIOLI FACILITA LA SALITA E LA DISCESA, MENTRE IL POGGIPIEDI SALDATO AL TELAIO CONSENTE UNA SEDUTA CONFORTEVOLE.

TELAIO IN METALLO ZINCATO A FREDDO INTRECCIO IN TEXTILENE E POLIETILENE. IMPILABILE.

COLD-GALVANIZED METAL FRAME
TEXTELINE AND POLYTHENE WEAVE.
STACKABLE.

SIMPLICITY IS THE STRONG POINT OF THE CANNES STOOL. ON TOP OF THE STACKABLE METAL FRAME IS A TEXTELINE AND POLYTHENE WOVEN SEAT. THE LACK OF ARMRESTS MAKES IT EASY TO GET ON AND OFF THE STOOL, WHILE THE FOOTREST WELDED TO THE FRAME PROMOTES A COMFORTABLE SITTING POSITION.

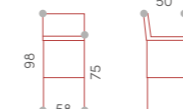
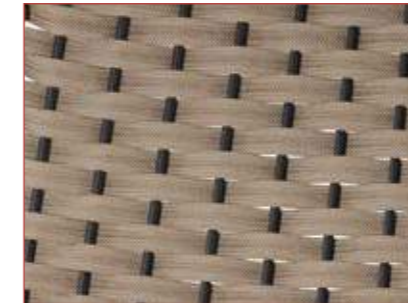

GS 936 CHAIR

POLTRONA IMPILABILE, STRUTTURA IN ALLUMINIO. RIVESTIMENTO IN TEXTILENE. SPESSORE TUBO 1,5 MM.

STACKABLE ARMCHAIR ALUMINIUM FRAME COVERED WITH TEXTYLENE. THICKNESS MM 1,5



GS 936 CHAIR

ALL'ARIA APERTA, CON UNA LEGGERA BREZZA E CON IL SOLE CHE SCALDA L'ATMOSFERA PIACEVOLMENTE CONVIVIALE. UNA POLTRONCINA IMPILABILE DALLA STRUTTURA IN ALLUMINIO E DAL RIVESTIMENTO IN TEXTILENE CON SPESSORE TUBO 1,5 MM CHE NON TEME CONFRONTI NEI SOLEGGIATI MOMENTI DI RELAX.

OUTDOORS, WITH A LIGHT BREEZE AND WITH THE SUN THAT WARMS THE PLEASANTLY FRIENDLY ATMOSPHERE. A STACKABLE ARMCHAIR WITH AN ALUMINIUM STRUCTURE AND TEXTILENE COVERING, WITH A 1.5 MM TUBE THICKNESS THAT IS SECOND TO NONE IN RELAXING MOMENTS UNDER THE SUN.

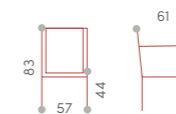

GS 939 CHAIR

ALL'ARIA APERTA, CON UNA LEGGERA BREZZA E CON IL SOLE CHE SCALDA L'ATMOSFERA PIACEVOLMENTE CONVIVIALE. UNA POLTRONCINA IMPILABILE DALLA STRUTTURA IN ALLUMINIO E DAL RIVESTIMENTO IN TEXTILENE CON SPESSORE TUBO 1,5 MM CHE NON TEME CONFRONTI NEI SOLEGGIATI MOMENTI DI RELAX.

POLTRONA IMPILABILE,
STRUTTURA IN ALLUMINIO
RIVESTIMENTO IN TEXTILENE.
SPESSORE TUBO 1,5 MM.

STACKABLE ARMCHAIR
ALUMINIUM FRAME COVERED
WITH TEXTYLENE. THICKNESS
MM 1,5

OUTDOORS, WITH A LIGHT BREEZE AND WITH THE SUN THAT WARMS THE PLEASANTLY FRIENDLY ATMOSPHERE. A STACKABLE ARMCHAIR WITH AN ALUMINIUM STRUCTURE AND TEXTILENE COVERING, WITH A 1.5 MM TUBE THICKNESS THAT IS SECOND TO NONE IN RELAXING MOMENTS UNDER THE SUN.



GS 941 CHAIR

POLTRONA IMPILABILE,
STRUTTURA IN ALLUMINIO
RIVESTIMENTO IN TEXTILENE.
SPESSORE TUBO 1,5 MM.

STACKABLE ARMCHAIR
ALUMINIUM FRAME COVERED
WITH TEXTYLENE. THICKNESS
MM 1,5

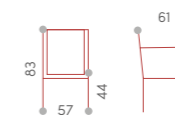

WINDI

ROCKING CHAIR

POLTRONA SOSPESA CON STRUTTURA IN ALLUMINIO E RIVESTIMENTO IN WICKER SINTETICO. CUSCINERIA SFODERABILE RIVESTITA CON TESSUTO ACRILICO. PORTATA MASSIMA GARANTITA 180 KG.

ROCKING CHAIR WITH ALUMINIUM VARNISHED FRAME AND WEAVED WITH ECOWICKER ROPE. CUSHIONS UPHOLSTERED WITH ACRYLIC FABRIC. MAXIMUM WEIGHT 180 KGS.



WINDI

ROCKING CHAIR

TRASPORTATI COME IN UN'ALTRA DIMENSIONE DI QUIETE E RELAX, SOSPESI A CONTEMPLARE LA PACE. WINDI È UNA VERA E PROPRIA ESPERIENZA DA VIVERE AL MEGLIO PER FAR DONDOLARE I PENSIERI IN UN AMBIENTE PRIVO DI TENSIONI E GODERE DI UNA FORMA UNICA ED ESCLUSIVA DEGLI SPAZI APERTI. IL TUTTO ALL'INSEGNA DELLO STILE, DELLA SICUREZZA E DELL'ELEGANZA.

GET CARRIED AWAY TO ANOTHER DIMENSION OF STILLNESS AND RELAXATION, CONTEMPLATING PEACE FLOATING IN A STATE OF SUSPENSION. WINDI IS AN AUTHENTIC EXPERIENCE FOR GENTLY SWAYING THOUGHTS IN A STRESS-FREE ENVIRONMENT AND FOR ENJOYING A UNIQUE AND EXCLUSIVE FORM OF OPEN SPACES. ALL IN A COMBINATION OF STYLE, SAFETY AND ELEGANCE.

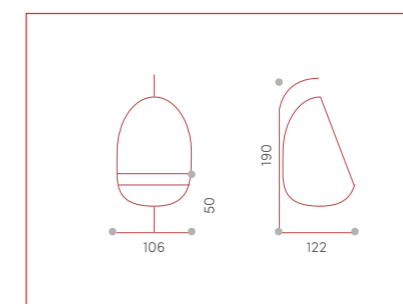

CAPRI RELAX LOUNGE

POLTRONA RELAX CON SCHIENALE RECLINABILE IN 5 POSIZIONI E POGGIAPIEDI CON STRUTTURA IN ALLUMINIO E RIVESTIMENTO IN WICKER SINTETICO. CUSCINERIA SFODERABILE RIVESTITA CON TESSUTO ACRILICO.

ALUMINIUM RELAX ARMCHAIRS WITH ADJUSTABLE BACK, 5 POSITIONS, AND ALUMINIUM FOOTREST. WEAVED WITH ECOWICKER ROPE. CUSHIONS UPHOLSTERED WITH ACRYLIC FABRIC.



CAPRI RELAX

SDRAIANDOSI SULLE MORBIDE PARTI IMBOTTITE E SORRETTI DA UNA STRUTTURA SOLIDA, AVVOLGENTE E DALLE DIMENSIONI GENEROSE SI POSSONO GUSTARE A PIENO TUTTI I MOMENTI DI SERENITÀ ALL'APERTO. CAPRI RELAX GRAZIE AI MORBIDI CUSCINI E ALLE 5 POSIZIONI CON CUI SI PUÒ RECLINARE LO SCHIENALE OFFRE UN COMFORT PERSONALE DAVVERO UNICO.

LYING ON THE SOFT PADDED PARTS AND SUPPORTED BY A GENEROUSLY DIMENSIONED SOLID, ENVELOPING STRUCTURE, YOU CAN ENJOY ALL YOUR OUTDOOR MOMENTS OF SERENITY. THANKS TO ITS SOFT CUSHIONS AND THE 5 RECLINABLE POSITIONS OF THE BACKREST, CAPRI RELAX OFFERS TRULY UNIQUE PERSONAL COMFORT.

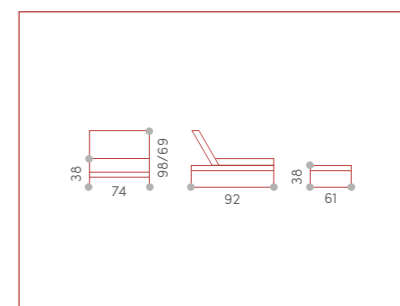

208

TAVOLI TABLES

VARCHI, DOVE FANTASIA E RELAX
TROVANO IL LORO PUNTO DI INCONTRO.
DISTACCHI, PER IMMERGERSI
NEI NOSTRI PENSIERI O IN ATTIMI
DI IRRIPETIBILE CONVIVIALITÀ.
ARMONIE DI FORME
CHE CREANO IMPATTI
VISIVI ED EMOTIVI.

OPENINGS WHERE FANTASY AND
RELAXATION FIND THEIR MEETING POINT.
DETACHMENT, TO IMMERSE OURSELVES
IN OUR THOUGHTS OR MOMENTS
OF UNIQUE CONVIVIALITY.
HARMONIES OF SHAPES
THAT CREATE VISUAL
AND EMOTIONAL IMPACTS.



TOP TABLE



TOP TABLE

TAVOLO ALLUNGABILE CON STRUTTURA IN ALLUMINIO
VERNICIATO E PIANO CON DOGHE IN TEAK GREZZO.

EXTENDABLE ALUMINIUM TABLE WITH SOLID TEAK RAW SLATS.

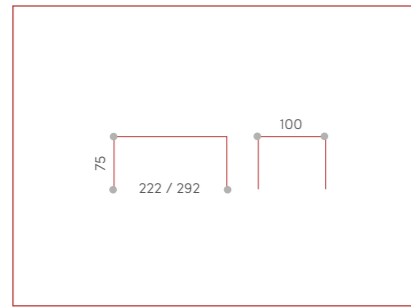

BARI TABLE



BARI TABLE

TAVOLO CON STRUTTURA IN ALLUMINIO E PIANO
IN PIETRA SINTERIZZATA.

ALUMIUM TABLE WITH SYNTERIZED STONE TOP.

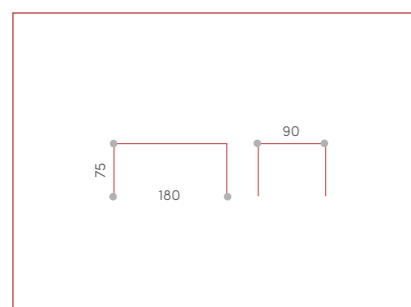

MILO



MILO TABLE

TAVOLO CON STRUTTURA IN METALLO VERNICIATO,
CON PIANO IN HPL.

STEEL TABLE, WITH HPL TOP.



PIANO OVALE
OVAL TOP

MILO TABLE

TAVOLO ALLUNGABILE CON STRUTTURA IN ALLUMINIO VERNICIATO, CON PIANO IN HPL.

EXTENDABLE ALUMINIUM TABLE, WITH HPL TOP.



75
200/300
100

PANAREA TABLE



PANAREA TABLE

TAVOLO ALLUNGABILE IN ALLUMINIO
VERNICIATO CON PIANO IN LAMIERA DI
ALLUMINIO SPESSORE 5 MM.

ALUMINIUM EXTENDABLE TABLE WITH
ALUMINIUM 5 MM. LAYER TOP.

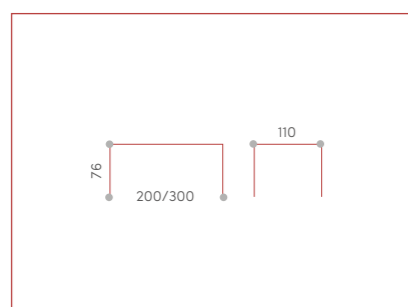
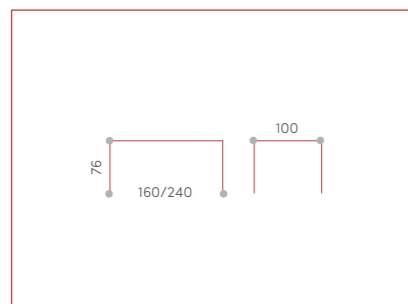

LIPARI TABLE



LIPARI TABLE

TAVOLO ALLUNGABILE IN ALLUMINIO
VERNICIATO CON PIANO IN DOGHE DI
ALLUMINIO SALDATO.

ALUMINIUM EXTENDABLE TABLE WITH
ALUMINIUM SLATS TOP.

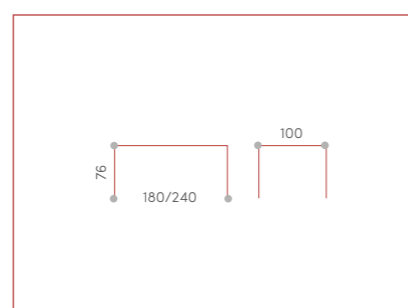

MIKONOS TABLE

TAVOLO ALLUNGABILE IN ALLUMINIO
VERNICIATO CON PIANO IN DOGHE DI
ALLUMINIO SALDATO.

ALUMINIUM EXTENDABLE TABLE WITH
ALUMINIUM SLATS TOP.

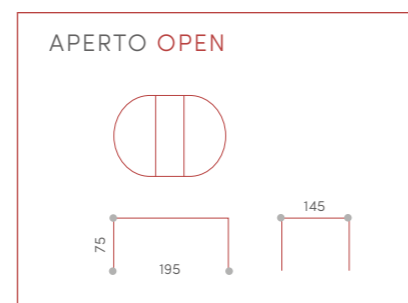
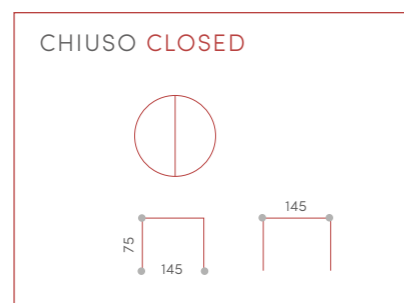

ISLAND COFFEE TABLE

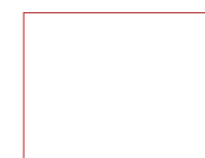

TAVOLINO IN ALLUMINIO CON PIANO
IN LAMIERA SPESSORE 5 MM.

ALUMINIUM COFFEE TABLE WITH
FULL ALU PLATE. 5 MM THICKNESS.



ISLAND COFFEE TABLE

ISLAND È COMPONIBILE E MULTIUSO. È LA SINERGIA PERFETTA CON L'AMBIENTE CIRCOSTANTE CHE SI REALIZZA SOLO QUANDO IL BELLO INCONTRA IL PRATICO, IL DESIGN SI SPOSA CON L'ESPERIENZA E LA PRATICITÀ DEGLI ELEMENTI SOVRAPPONIBILI.

ISLAND IS MODULAR AND MULTI-PURPOSE. IT IS THE PERFECT SYNERGY WITH THE SURROUNDING ENVIRONMENT, REALISED ONLY WHEN BEAUTY MEETS PRACTICAL ASPECTS, DESIGN COMBINED WITH THE EXPERIENCE AND PRACTICALITY OF THE OVERLAPPING ELEMENTS.



ISLAND SMALL



ISLAND MEDIUM



ISLAND BIG



JOLLY COFFEE TABLE

TAVOLINO IN ALLUMINIO CON PIANO IN LAMIERA DI ALLUMINIO. SPESSORE 5 MM.

ALUMINIUM COFFEE TABLE WITH FULL ALU PLATE. 5 MM THICKNESS.

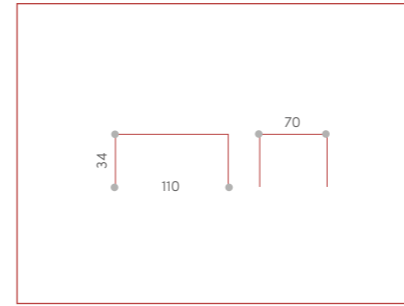

GT 927 TABLE

TAVOLINO IN ALLUMINIO CON PIANO IN LAMIERA DI ALLUMINIO. SPESSORE 5MM.

ALUMINIUM COFFEE TABLE WITH FULL ALU PLATE. 5 MM THICKNESS.

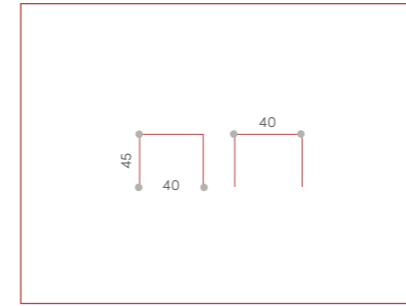

MALDIVES COFFEE TABLE

TAVOLINO CON STRUTTURA IN ALLUMINIO.
PIANO E ZAVORRA IN LAMIERA DI ALLUMINIO
SPESSORE 5 MM.

ALUMINIUM COFFEE TABLE. TOP AND WEIGHT
WITH ALUMINIUM LAYER WITH 5MM THICKNESS.

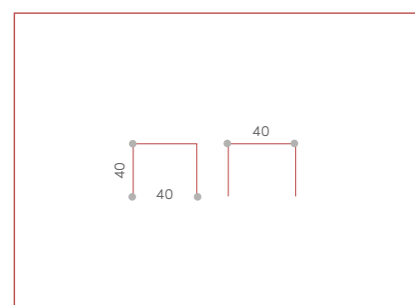

244

LAMPADE LAMPS

LAMPADE COME PUNTI LUCE DI ASSOLUTO RIFERIMENTO, COME STELLE NEL CIELO. UNA GUIDA PER CERCARSI E RITROVARSI IN UN AMBIENTE FAMILIARE E CONOSCIUTO: LA PROPRIA CASA, UN RIFUGIO, UN APPRODO ILLUMINATO E CARATTERIZZATO DA ELEGANZA E DESIGN.

LAMPS AS A REFERENCE SERIES OF LIGHT POINTS, LIKE STARS IN THE SKY. A GUIDE FOR SEEKING AND FINDING ONESELF IN A FAMILIAR AND WELL-KNOWN ENVIRONMENT: ONE'S HOME, A REFUGE, AN ELEGANT AND DESIGN-DRIVEN ILLUMINATED DESTINATION.

STAR LAMP

LAMPADA CON STRUTTURA IN METALLO E PARTE ILLUMINANTE IN MATERIALE PLASTICO ULTRALEGGERO. ILLUMINAZIONE A LED A 8 COLORI RADIOCOMANDATA TRAMITE TELECOMANDO. SENSORE LUCE PER L'ACCENSIONE AUTOMATICA. CARICAMENTO DELLA BATTERIA TRAMITE PANNELLO SOLARE O CAVO USB.

STEEL FRAME LAMP WITH LIGHTING PART MADE PE AND LED LIGHT. IT WORKS WITH 8 DIFFERENT COLORS SELECTED BY A REMOTE CONTROL. SENSOR LIGHT FOR AN AUTOMATIC ON/OFF. RECHARGEABLE WITH SOLAR PANEL OR USB CABLE.

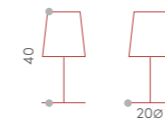

LUX ALU

LAMPADA DA TAVOLO O DA TERRA CON STRUTTURA IN ALLUMINIO, ILLUMINAZIONE A LED CON TRE LIVELLI DI INTENSITÀ. CARICAMENTO BATTERIA TRAMITE PANNELLO SOLARE OPPURE CARICATORE USB. ADATTA AD USO ESTERNO, RESISTENTE ALL'ACQUA.

ALUMINIUM TABLE OR FLOOR LAMP, LED LIGHT WITH 3 DIFFERENT INTENSITY LEVELS. RECHARGEABLE WITH SOLAR PANEL OR USE CABLE. SUITABLE FOR OUTDOOR USE, WATERPROOF ITEM.

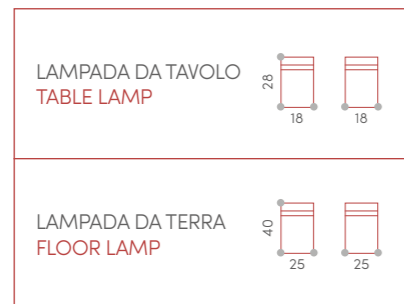

LUX TEAK

LAMPADA DA TAVOLO O DA TERRA CON STRUTTURA IN TEAK, ILLUMINAZIONE A LED CON TRE LIVELLI DI INTENSITÀ. CARICAMENTO BATTERIA TRAMITE PANNELLO SOLARE OPPURE CARICATORE USB. ADATTA AD USO ESTERNO, RESISTENTE ALL'ACQUA.

TEAK TABLE OR FLOOR LAMP, LED LIGHT WITH 3 DIFFERENT INTENSITY LEVELS. RECHARGEABLE WITH SOLAR PANEL OR USE CABLE. SUITABLE FOR OUTDOOR USE, WATERPROOF ITEM.



PROGETTO GRAFICO - M. SCHIAVI
INTERLACED SRL
FINITO DI STAMPARE
FEBBRAIO 2023
DALLE POLIGRAFICHE SAN MARCO

WWW.GRATTONISEDIE.IT

GRATTONI SRL
VIA BRAIDE MATTE 7
33048 SAN GIOVANNI AL NATISONE (UD) ITALIA
TEL. +39 0432 756144
FAX +39 0432 743558
INFO@GRATTONISEDIE.IT
COMMERCIALE@GRATTONISEDIE.IT
GRATTONISEDIE@GMAIL.COM